

The IBM logo, consisting of the letters "IBM" in a bold, sans-serif font, is positioned inside a dark rectangular box.

## Systems Reference Library

### IBM 2703 Transmission Control Component Description

This publication provides a detailed description of the capabilities, features, and communication facilities required for the IBM 2703 Transmission Control Unit. The capabilities of the unit are grouped by: start-stop capabilities; and binary-synchronous capabilities. All items of a general nature are discussed in the section, "Detailed Description of Operations."

The operator's controls and a detailed description of the communication facilities to which the 2703 can be attached are contained in the Appendix. For a complete listing of all SRL publications available in the IBM System/360 library, including abstracts, consult the IBM System/360 Bibliography, Form A22-6822.

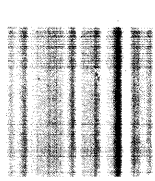
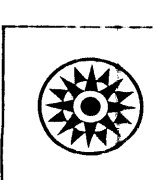
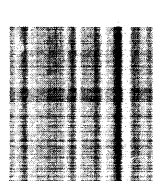
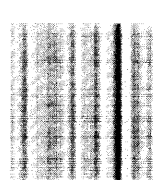
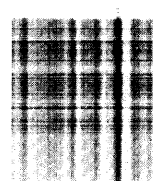
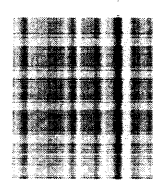
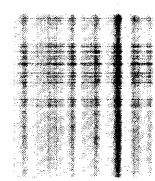
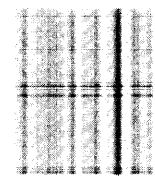
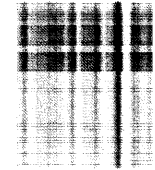

## PREFACE

This manual is written as a reference text and is intended to cover all the major facets of the IBM 2703 from a hardware viewpoint. Further information pertaining specifically to the IBM System/360 is contained in the IBM System/360 Principles of Operation manual, Form A22-6821. Numerous programming publications describing the various telecommunications programs are also available. All these publications are listed in the IBM System/360 Bibliography, Form A22-6822.

### Major Revision, May 1967

This edition is a major revision to, and obsoletes, A27-2703-0. It incorporates Technical Newsletters N27-3010 and N27-3012. A complete review of this edition is recommended, since all major sections of this manual have been revised.

The 2703 Configuration previously included in this manual has been removed and incorporated in the IBM System/360 Data Communications and Acquisition Configurator manual, Form A22-6824.

The users of this manual are cautioned that contents are subject to change at any time and without prior notice by IBM. Significant changes or additions to the contents of this publication will be reported in subsequent revisions or Technical Newsletters.

This manual has been prepared by the IBM Systems Development Division, Product Publications, Dept. 860, P. O. Box 12275, Research Triangle Park, North Carolina 27709. Address comments concerning the manual to this address.

## CONTENTS

INTRODUCTION . . . . .	5	BSC (BINARY SYNCHRONOUS COMMUNICATIONS) CAPA- BILITIES . . . . .	47
General Description of Operations . . . . .	7	Introduction to BSC . . . . .	47
DETAILED DESCRIPTION OF OPERATIONS . . . . .	11	General Description of BSC Operations . . . . .	47
Communications-Line Addressing . . . . .	12	Synchronous Operations . . . . .	50
Operation with the Multiplexer Channel . . . . .	14	Binary Synchronous Commands . . . . .	55
Programming Considerations . . . . .	15	Effect of Halt I/O Instruction and Zero Byte Count . . . . .	62
Special Features Summary . . . . .	19	APPENDIX A. OPERATOR'S CONTROL PANEL . . . . .	65
START/STOP COMMUNICATIONS CAPABILITIES . . . . .	23	Indicators . . . . .	65
Line Control . . . . .	23	Switches . . . . .	65
Transmit Operation (Write Command) . . . . .	24	Metering . . . . .	65
Receive Operation (Read Command). . . . .	24	APPENDIX B. COMMUNICATIONS FACILITIES . . . . .	68
Commands . . . . .	25	Common-Carrier-Provided Facilities . . . . .	68
Status-Byte Conditions . . . . .	28	Privately Owned Communications Facilities . . . . .	69
Sense-Byte Conditions . . . . .	30	INDEX . . . . .	71
Start/Stop Special Features . . . . .	35		
Terminal Control Operations . . . . .	39		

## ILLUSTRATIONS

Figure	Page	Figure	Page
1. IBM 2703 Transmission Control . . . . .	iv	10. Total Low-Speed Lines Available by 2712 Model Configurations . . . . .	40
2. Data Communications Units Attachable to the 2703 . . . . .	6	11. Operation of Two System/360 Computers over a Communications Line . . . . .	52
3. 2703-Internal Organization . . . . .	8	12. Code Translation of a Received Character (to EBCDIC or ASCII-8) . . . . .	52
4. Main Control Words (MCW-1, MCW-2) and Main Data Words (MDW-1, MDW-2) . . . . .	17	13. Communications Facilities for BSC . . . . .	55
5. Bit Configuration of a "G" Character (Serialized) . . . . .	23	14. Multipoint Configuration . . . . .	56
6. Line-Control Characters . . . . .	23	15. Transparent Operation . . . . .	60
7. Start/Stop Commands . . . . .	26	16. Operator's Panel . . . . .	66
8. Line Base Configurations. . . . .	37		
9. Typical 2712 Configuration . . . . .	39		



Figure 1. IBM 2703 Transmission Control

The IBM 2703 Transmission Control (Figure 1) enables an IBM System/360 to communicate with input/output devices over a variety of communications facilities. The 2703 permits users of System/360 Models 30, 40, and 50 to combine data processing and data communications within the same system. The users of System/360 Models 65 and 75 accomplish the same by using the IBM 2870 Multiplexer Channel in conjunction with the 2703. The 2703 is a multiline communications-control unit that is attached to a multiplexer channel of a System/360 processor.

### Data-Communication Units

The 2703 directs and controls information flow between the system and a variety of remote communications terminals over leased common-carrier private-line facilities, common-carrier switched facilities, or equivalent privately owned communications facilities. Data-communication equipment that can be connected to the IBM 2703 is included in the following listing, and is illustrated by Figure 2. The operating speeds available are indicated in bits per second (bps) and usually also in characters per second (cps).

- IBM 2711 Line Adapter Unit.
  - IBM 2712 Remote Multiplexer.
  - IBM 1030 Data Collection System--at 600 bps/60 cps; or 600 bps/14.8 cps.
- NOTE: The IBM 1032 Digital Time Unit cannot be attached to a 2703.
- IBM 1050 Data Communication System--at 134.5 bps/14.8 cps; or 75 bps/8.33 cps.
  - IBM 1060 Data Communication System--at 134.5 bps/14.8 cps.
  - IBM 1070 Process Communication System--at 134.5 bps/14.8 cps; or 600 bps/66.6 or 13.3 cps.
  - IBM 2740 or 2741 Communications Terminal--at 134.5 bps/14.8 cps.
  - AT&T 83B2/83B3 Type Selective Calling Terminals--at 45.5, 56.89, or 74.2 bps.
  - Western Union Plan 115A Terminals--at 45.5, 56.89, or 74.2 bps.
  - Common-Carrier TWX Stations (Model 33/35 Type, 8-level code)--at 110 bps only.
  - Another IBM System/360 via an IBM 2701 Data Adapter Unit (equipped with the appropriate Synchronous Features)--at 1200 bps/150 cps; 2000 bps/250 cps; or 2400 bps/300 cps.\*

- Another IBM System/360 via an IBM 2703 Transmission Control (equipped with the appropriate Synchronous Features)--at 1200 bps/150 cps; 2000 bps/250 cps; or 2400 bps/300 cps.\*
- IBM 2780 Data Transmission Terminal--at 1200 bps/150 cps; 2000 bps/250 cps; or 2400 bps/300 cps.\*
- IBM 1130 Computing System (equipped with the Synchronous Communications Adapter feature)--at 1200 bps/150 cps; 2000 bps/250 cps; or 2400 bps/300 cps.\*

### Attached Communications Lines

The 2703 can accommodate from 8 (4 for synchronous) to 176 half-duplex lines. Each line requires one nonshared subchannel on the multiplexer channel. The 2703 operates in half-duplex mode with respect to the messages being communicated.

The 2703 is flexible in line capacity, transmission code, and speed. A basic unit may have as few as eight lines (four for synchronous) and operate at speeds up to 600 bps for start/stop communications (asynchronous), or up to 2400 bps for Binary Synchronous Communications (BSC, or synchronous). The 2703 can have as many as 176 lines operating at speeds up to 180 bps, have 72 lines operating at speeds up to 600 bps, or have up to 48 lines operating at speeds up to 2400 bps. Many combinations are possible; however, the individual system and 2703 configuration determine the specific line limitations. For details on specific communications facilities, refer to Appendix B.

In communications with the terminal, the 2703 transmits and receives serially by bit and serially by character. Character buffering of up to four bytes is accomplished within the 2703 unit for start/stop type communications, while eight bytes can be buffered for synchronous (BSC) operations. When communicating with the channel, the 2703 operates in multiple-byte multiplex mode to request or transfer a short burst of up to four bytes each time a line requires service. On both input and output operations with the channel, any message buffering is performed by the processing unit. The 2703 does not impose restrictions on message length. All necessary bit-byte conversions, data control, and matching to common-carrier equipment is accomplished in the transmission control unit.

---

\*Character rates are based on the use of USASCII or EBCDIC as the transmission code. Higher character rates are achieved with Six-Bit Transcode.

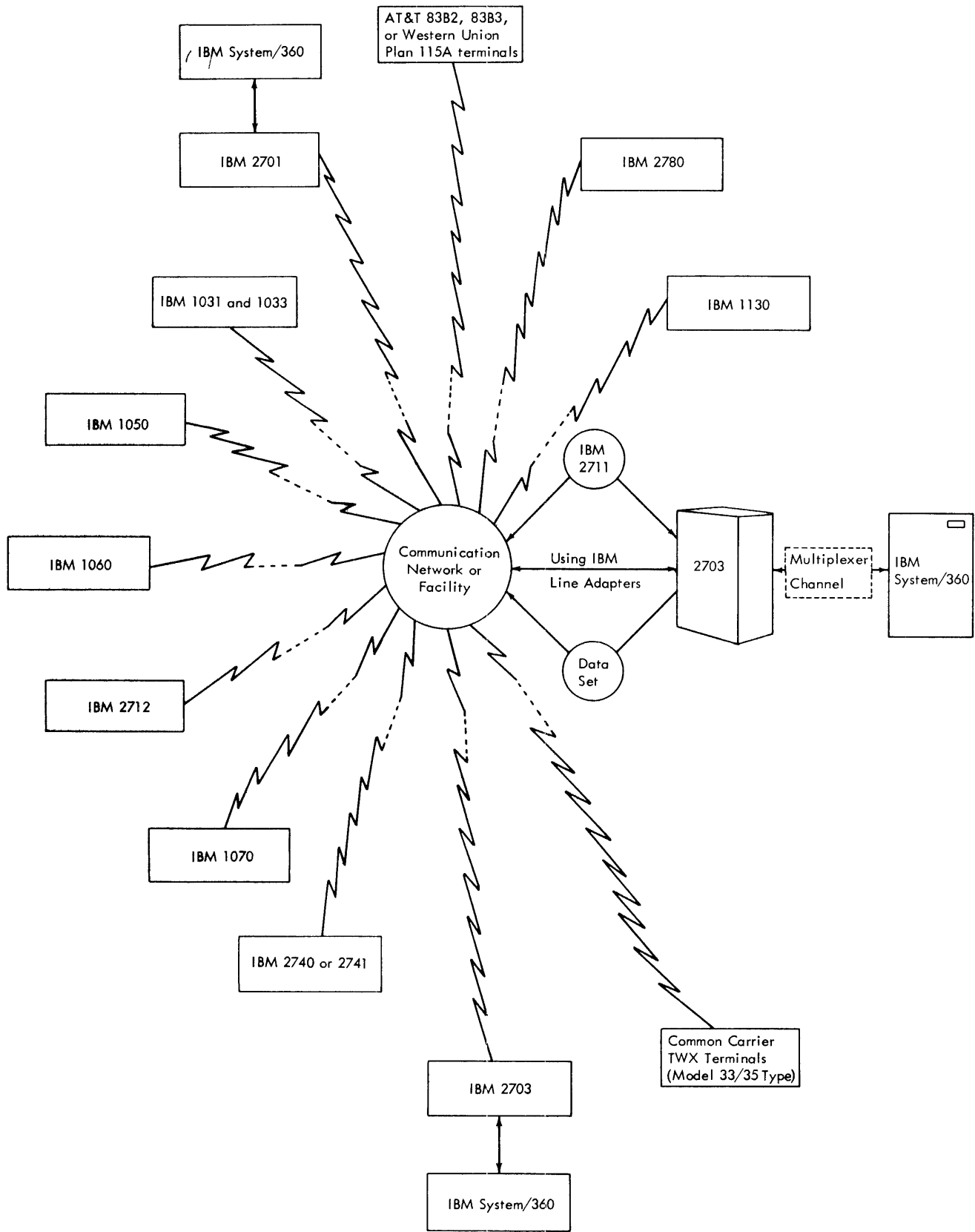

Figure 2. Data Communication Units Attachable to the 2703

## Transmit and Receive Operations

The 2703 can accommodate various transmission codes not exceeding an eight-level, eleven-unit structure (eight data bits and three start/stop bits). For start/stop type transmission, the start and stop bits are generated for transmission onto the communications line. On receive, the start and stop bits are removed from the code structure before each byte is transferred to the multiplexer channel. For synchronous operations, sync idles are inserted and removed on a similar basis. All transmission codes of less than eight bits are placed in processor storage in the low-order bit positions, with the proper number of high-order zeros inserted.

In transmit or receive operations, each attached communications line is scanned to determine whether it requires data from the processor for transmission, or whether any line has data to send to the processor. During receive, the 2703 samples signals on the line to derive bits, and it later assembles these bits into characters that are transferred to the channel as data bytes. To store these bits before assembly, a delay-line storage is used. To assemble a byte, magnetic-core storage is used for start/stop and the delay-line storage is used for BSC. A maximum of four bytes (eight bytes for BSC) can be assembled and stored before being transferred to the multiplexer channel; a parity bit is generated by the 2703 before transfer of the byte to the channel.

For data transmission from the 2703, groups of up to four bytes are transferred from processor storage (main storage) and stored in the 2703 magnetic core storage before transmission over the communications line. The one-byte characters are then transferred serially by bit for start/stop and serially by character for BSC to the delay-line storage. When transmission of the last character is started, a request for four additional bytes is sent to the multiplexer channel.

All character and bit control, character decoding, data handling, and matching to common-carrier equipment is accomplished by the functional sections within the 2703 (see Figure 3). These sections are described under "General Description of Operations."

### GENERAL DESCRIPTION OF OPERATIONS

Here, in general terms, is described the operation of the main internal units or functional sections of the 2703. These sections (Figure 3) are the I/O-interface controls, common controls and storage, terminal controls, line bases, and line sets. A general description of the IBM 2711 Line Adapter Unit and IBM 2712 Remote Multiplexer is also presented here.

## I/O-Interface Controls

The I/O-interface-controls section connects the 2703 to the System/360 multiplexer channel. It recognizes signal sequences from the channel and returns the required sequences in response. The response is variable, depending on the status of the other functional sections. Command buffering and multiple-byte buffering for data is provided from main storage and from the multiplexer channel. If the channel wishes to transmit or receive through the 2703 control unit, it initiates this operation by issuing a Start I/O to the desired communications line. The data transfer then occurs in short bursts of up to four characters or bytes. Each byte consists of eight data bits plus an odd-parity bit.

The operation of each communications line is controlled through a CCW (channel-command word) stored in the processor core storage. See "System/360--I/O Operation" under "Detailed Description of Operations." The I/O operation is initiated for a given communications line by issuing the Start I/O instruction with the subchannel address corresponding to the desired communications line specified in the instruction format. The 2703 will terminate both input and output operations after data transfer occurs, unless some unusual condition exists.

## Common Controls and Storage

This section accepts commands and data from the multiplexer channel (via the I/O-interface-controls section). It performs all the functions that are common to all communications lines attached to the 2703. A magnetic-core storage is provided to store control information and to buffer commands and data. Each communications line has storage reserved for its exclusive use, for its main control words (MCW-1 and MCW-2), and for its main data words (MDW-1 and MDW-2)--see Figure 4. The storage locations are accessed in a prescribed sequence or priority.

The control words buffered in 2703 storage contain fields that define such areas as: assembly/disassembly, character address (within the data word), character shift (upper or lower case), mode of operation (text or control), command, longitudinal redundancy check (LRC) accumulation, sense information, and unit status condition.

The common-controls-and-storage section receives data in groups of up to four bytes and transfers them bit-by-bit through the line base to the communications line. When the line presents bits to the 2703 line base, the line-base section receives the data bit-by-bit and stores this data in the control word. The data is stored in byte form in the main control word (MCW-1) and is stored in the main data

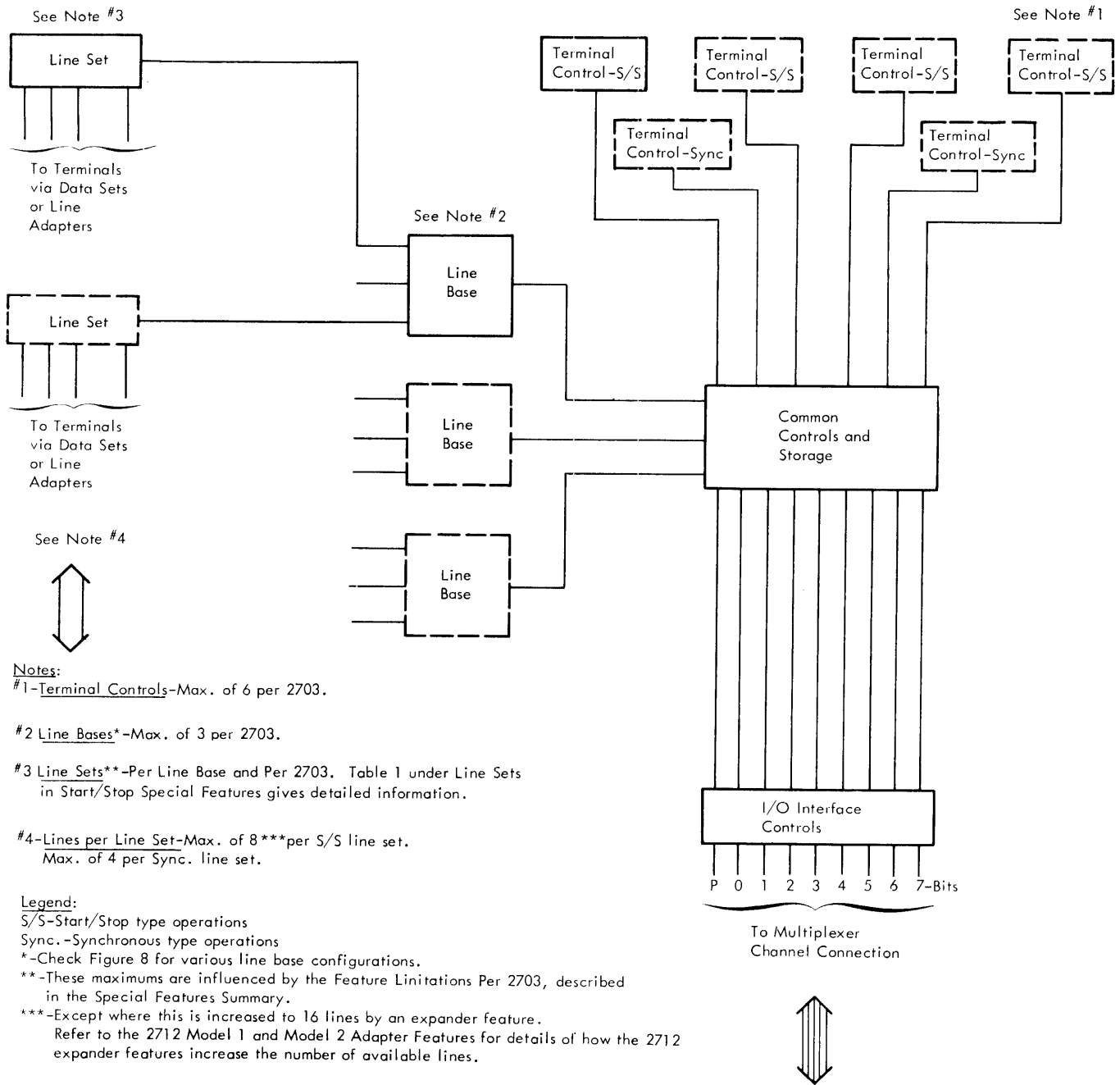

Notes:

#1-Terminal Controls-Max. of 6 per 2703.

#2 Line Bases\*-Max. of 3 per 2703.

#3 Line Sets\*\*-Per Line Base and Per 2703, Table 1 under Line Sets in Start/Stop Special Features gives detailed information.

#4-Lines per Line Set-Max. of 8\*\*\*per S/S line set.  
Max. of 4 per Sync. line set.

Legend:

S/S-Start/Stop type operations

Sync.-Synchronous type operations

\*-Check Figure 8 for various line base configurations.

\*\* -These maximums are influenced by the Feature Limitations Per 2703, described in the Special Features Summary.

\*\*\*-Except where this is increased to 16 lines by an expander feature.

Refer to the 2712 Model 1 and Model 2 Adapter Features for details of how the 2712 expander features increase the number of available lines.

Figure 3. 2703-Internal Organization



word (MDW-1, 2) in the common-controls-and-storage section. When four bytes are accumulated, they are transferred to the multiplexer channel via the I/O-interface controls.

### Terminal Controls

This section performs functions associated with a particular type of terminal equipment. The terminal-controls section acts as the extension of common controls, performing such unique duties as: determining character bit length, character-sequence recognition, shift-character recognition, pad-character control, and initiating LRC checking. A terminal control is assigned by line set, and all lines connected to a specific line set must be of the same terminal type. The addressing circuit that selects the line also selects the associated delay-line storage (base control word--delay-line type storage), MCW, and terminal control.

### Line Bases

The line-base section performs bit sampling while accepting bits directly from the line adapters during a receive operation. It buffers and time-multiplexes the data before sending the bits (characters, for synchronous operations) to the common-controls-and-storage section. The reverse procedure takes place during a transmit operation. A base-control word in the delay line of the line base is used for bit buffering (character buffering, for synchronous operations) and bit sample control. The line base is limited to a certain number of lines, depending on the type of base.

### Line Sets

The line sets interface the communications facilities (lines) to the 2703 and provide bit buffering for the Transmit Data line. At least one line set must be selected for 2703 operation. Each line set consists of eight line adapters (four, for synchronous), with each adapter servicing one communications line.

### IBM 2711 Adapter Unit

This is a free-standing unit that provides housing and power for up to 32 IBM Line Adapters (Shared-Line, Leased-Line, and Limited-Distance Type 2--eight miles). These line adapters interface with the 2703 via the Data Line Set special feature, with one line set required for each eight lines. The 2711 may be attached on a per-line basis to more than one 2703. Any combination of line adapters up to 32 can be accommodated by the 2711.

### IBM 2712 Remote Multiplexer

The 2712 consists of a free-standing unit at the remote communications point and several special features available for adding to the 2703. These 2703 features allow up to 10 lines operating at 134.5 bps or 14 lines operating at 74.2 bps to be bit-multiplexed onto one voice-grade line. Refer to "2712 Model 1 and Model 2 Adapter Features" under "Start/Stop Special Features" for further details.



SYSTEM/360--I/O OPERATION

Input/output operations for the IBM 2703 are initiated and controlled by information with two types of formats: instructions and commands. Instructions are decoded by the CPU and are part of the CPU program. Commands are decoded and executed by the channels and I/O devices, and initiate I/O operations, such as reading and writing. One or more commands arranged for sequential execution form a channel program. Both instructions and commands are fetched from main storage and are common to all types of I/O devices, although the modifier bits in the command code may specify device-dependent conditions for the execution of a data-transfer operation at the device.

The CPU program initiates 2703 I/O operations with the Start I/O instruction. This instruction identifies the channel and the device, and causes the channel to fetch the channel-address word (CAW) from a fixed location in main storage. The format for the CAW is:

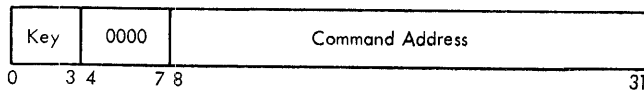

The CAW contains the protection key and designates the location in main storage from which the channel subsequently fetches the first channel-command word (CCW). The CCW specifies the command to be executed and the storage area, if any, to be used. The format for the CCW is:

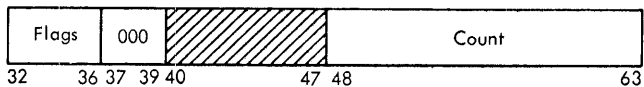
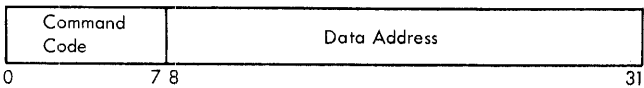

If the subchannel associated with the addressed I/O device is not busy, the channel attempts to select the device by sending the address of the device to all control units attached to the channel. The control unit that recognizes the address connects itself logically to the channel and responds to its selection by returning its address. The channel subsequently sends the command-code part of the CCW over the interface, and the device responds with a status byte indicating whether it can execute the command.

NOTE: The 2703 does not operate in burst mode; neither can the 2703 operate concurrently on the same channel with any other device operating in burst mode.

At this time, the execution of Start I/O is terminated. The results of the attempt to initiate the execution of the command are indicated by setting the condition code in the program-status word (PSW), and, under certain conditions, by storing pertinent information in the channel-status word (CSW).

If the operation is initiated at the device and its execution involves transfer of data, the subchannel is set up to respond to service requests from the device and assumes further control of the operation. In the case of operations that do not require any data to be transferred to or from the device, the device may signal the end of the operation immediately on receipt of the command code.

An I/O operation may involve transfer of data to one storage area, designated by a single CCW, or to a number of noncontiguous storage areas. In the latter case, a list of CCW's is used for execution of the I/O operation, each CCW designating a contiguous storage area, and the CCW's are said to be coupled by data chaining. Data chaining is specified by a flag in the CCW and causes the channel to fetch another CCW upon the exhaustion or filling of the storage area designated by the current CCW. The storage area designated by a CCW fetched on data chaining pertains to the I/O operation already in progress at the 2703, and the 2703 is not notified when a new CCW is fetched. Provision is made in the CCW format for the programmer to specify that, when the CCW is decoded, the channel request an I/O interruption as soon as possible, thereby notifying the CPU program that chaining has progressed to a particular CCW in the channel program.

Termination of the I/O operation normally is indicated by two conditions: Channel End and Device End. The Channel End condition indicates that the I/O device has received or provided all information associated with the operation and no longer needs channel facilities. The Device End signal indicates that the I/O device has terminated execution of the operation. For the 2703, the Device End condition always occurs concurrently with the Channel End condition.

The conditions signaling the termination of an I/O operation can be brought to the attention of the program by I/O interruptions. These conditions cause storing the CSW, which contains additional information concerning execution of the operation. At the time the Channel End/Device End condition is generated, the channel identifies the program the

last CCW used and provides its residual byte count, thus indicating the extent of main storage used. Both the channel and the device can provide indications of unusual conditions with Channel End. The Channel End/Device End condition can be accompanied by error indications from the device.

Facilities are provided for the program to initiate execution of a chain of operations with a single Start I/O. When the chaining flags in the current CCW specify command chaining and no unusual conditions have been detected in the operation, the receipt of the Channel End/Device End signal causes the channel to fetch a new CCW and to initiate a new command at the device. A chained command is initiated by means of the same sequence of signals over the I/O interface as the first command specified by Start I/O. The ending signals that occur at the termination of an operation initiated by a CCW specifying command chaining are not made available to the program when another operation is initiated by the command chaining; the channel continues execution of the channel program. If, however, an unusual condition has been detected, the ending signals cause suppression of command chaining and termination of the channel program.

Conditions that initiate I/O interruptions are asynchronous to activity in the CPU, and more than one condition can occur at the same time. The channel and the CPU establish priority among the conditions so that only one interruption request is processed at a time. The conditions are preserved in the I/O devices and subchannels until accepted by the CPU.

Execution of a 2703 operation, or chain of operations, thus involves up to three levels of participation:

1. Except for the effects caused by the integration of CPU and channel equipment, the CPU is busy for the duration of execution of Start I/O, which lasts at most until the addressed I/O device responds to the first command.
2. The subchannel is busy with the execution from the initiation of the operation at the I/O device until the Channel End condition for the last operation of the command chain is accepted by the CPU.
3. The 2703 is busy from the initiation of the first command until the Channel End/Device End condition associated with the last operation is accepted or cleared by the CPU.

A pending Channel End/Device End condition causes the associated device to appear busy and normally blocks all communications through the subchannel. Thus each subchannel is restricted to the assignment of only one communications line. Once this communications line is assigned to the sub-

channel, no additional assignment can be made to this subchannel.

## COMMUNICATIONS-LINE ADDRESSING

The 2703 appears as a control unit to the IBM System/360. Two individual 2703's can be attached to the multiplexer channel with each 2703 occupying the place of one control unit. Actually, eight 2703's can be attached to the same multiplexer channel; however, channel-addressing restrictions normally make this impractical.

Each communications line attached to the 2703 is identified by a unique I/O address. This address is specified by a 16-bit binary number that appears in the address field of the I/O instruction. For 2703 operation, this I/O address consists of two parts: a channel address, and a communications-line address. The eight high-order bit positions of this field specify the channel address. However, since only channels 0-6 are available to the 2703, the five high-order positions of this byte are unused for channel addressing for all 2703 operations. The low-order eight bits specify the communications line attached to the 2703. The basic I/O-address format for the System/360 is as follows:

0000 0xxx	xxxx xxxx	1. Channel Address (restricted to 0-6 range)
Byte 1	Byte 2	2. 2703 Line Address

The complete addresses needed by the System/360 to address each of ten half-duplex communications lines connected to a 2703 (which, in turn, is connected to a specific multiplexer channel) are:

0000 0xxx 0000 0000	0000 0xxx 0000 0101
0000 0xxx 0000 0001	0000 0xxx 0000 0110
0000 0xxx 0000 0010	0000 0xxx 0000 0111
0000 0xxx 0000 0011	0000 0xxx 0000 1000
0000 0xxx 0000 0100	0000 0xxx 0000 1001

The assignment of addresses to particular start/stop lines is done in groups of eight and must be done in a particular manner when configuring a system. For synchronous type lines, address assignments are done in groups of four lines.

The 2703 requires that the lowest address within the 2703 begin at a specific address boundary. The addresses are then assigned by group, as previously indicated, consecutively from the low-address boundary to the highest valid address (or some group increment below this address). The specific considerations necessary when assigning 2703 addresses are covered in detail under "Address-Assignment Considerations."

A specific line base is assigned as the first line base within the continuous span of addresses. Then a line set of eight line adapters is added for this line base. As many lines as desired (up to eight lines for start/stop, or four lines for synchronous operation) are attached to this line set. Addresses are assigned to all eight lines even if lines are not attached. When the first line base is filled--or has as many lines attached as desired--the addresses are assigned to the second line base in the same manner. Similarly, addresses are assigned to the third line base if it is attached to the 2703.

If two 2703's are placed on the channel, the second 2703 may be placed with its lowest address in the next increment of 16 not assigned to the first 2703. Address assignment has no bearing on the priority of any particular line. This is a function of the type of line base only.

Address-Assignment Considerations

Numerous things should be considered when determining the 2703 address assignments. However, all these various items can be associated with the following list of major considerations involving address assignment:

1. A multiplexer channel can accommodate a maximum of 256 individual addresses.

NOTE: Each address is associated with an individual subchannel within the multiplexer channel.

The capabilities of a specific channel are dictated by the IBM System/360 processor model employed and the available core storage. Refer to "Maximum Lines Available by Processor Model."

2. The specific address range available for assignment is 0 to 255.
3. Any one 2703 is limited to a maximum of 176 individual addresses (or lines).
4. The low-address boundary for address assignment should be either 0 or a 16-unit increment thereof (for example--16, 32, or 48).

NOTE: A boundary of 48 should be used if convenient. This starting number reserves sufficient positions to allow the channel attachment of other devices with standard assigned addresses (for example, the standard assigned address for the 1050 Documentary Console is 31 or '1F'\*). This also simplifies installation, since the low-boundary address of 48 is prewired before shipping.

5. The high-address boundary must be an even increment of either 8 (for start/stop) or 4 (for synchronous) from the low-address boundary within the 2703.
6. The lowest address within the 2703 is always assigned as the wrap address. The wrap

address is the address of the line used to read data back to the channel from any line issued the Wrap command. The wrap address and its associated line can be used for normal transmission at all times, except when the 2703 is being checked with a Wrap command. Refer to "Automatic Wrap-around" under "Programming Considerations."

Maximum Lines Available by Processor Model

Each half-duplex communications line requires a separate subchannel within the multiplexer channel. The addresses for these lines are assigned sequentially on the 2703, normally starting at address 16. (See item 4 under "Address-Assignment Considerations.") A second 2703 can be attached to the same channel. The low-address boundary of the second 2703 is the first available address in the next increment of 16 above the first 2703. Different numbers of subchannels are available on the IBM System/360 Models 30, 40, 50, 65, and 75. The maximums are given in the following as a function of the processor and the minimum core-storage size. In the case of the IBM 2780 Multiplexer Channel, the number of subchannels is not dependent on the core storage available.

<u>Processor Model</u>	<u>Number of Subchannels</u>	<u>Minimum Core-Storage Size (Bytes)</u>
Model C 30	32	8K
Model D 30	96	16K
Model E/F 30	224	32K-64K and Feature #5250*
Model D 40	16	16K
Model E 40	32	32K
Model F 40	64	64K
Model G/H 40	128	128K
Model F 50	64	64K
Model G 50	128	128K
Model H/I 50	256	256K-512K and Feature #5250*

<u>Processor Model with 2870</u>	<u>Number of Subchannels</u>
Model 65	192
Model 75	192

\*Additional Multiplexer Subchannels special feature

\* ' ' is Hexadecimal representation.

## Channel-Attachment Restrictions

The following restrictions pertain to the attachment of any 2703 to the multiplexer channel.

1. The 2703 should have the first control-unit position on the channel; in other words, it should be the first to receive the channel-scanning signals. When two 2703's appear on the same channel, they will have sequential priority.
2. No shared subchannels will be allowed on the multiplexer channel when more than 128 subchannels are required. In any case, if devices using a shared subchannel are physically attached to the channel, they must not be operated while the 2703 is in operation.
3. The maximum line speed for any lines attached to the 2703 is:  
Start/stop type lines--600 bps  
Synchronous (BSC) type lines--2400 bps
4. The maximum number of lines attached to any one 2703 is determined by the type of lines and line mix. Figure 8 provides a complete listing of maximum lines by the various possible line-base configurations.

## OPERATION WITH THE MULTIPLEXER CHANNEL

The 2703 connects to and operates with the multiplexer channel via the I/O interface. This interface consists of byte buses (In and Out) and tag lines that indicate the type of information on the byte buses (e.g., command, address, data, and status), channel-interlock controls, and interface-scanning signals. The scanning signals and interlocks establish priority among different 2703's or other control units attached to the multiplexer channel. When the 2703 requires data transfer on any of its communications lines (line 14, for example), the scanning signal is intercepted by the 2703 and an interlock lead is raised, indicating the interception of the scanning signal to the multiplexer channel. The 2703 places the address of the line requesting service on the Input bus. When the 2703 receives acknowledgment from the channel that the appropriate control word has been retrieved from storage, data transfer between the 2703 and the channel begins. When transfer of a data byte (or bytes) is complete, the interlock is dropped and the channel resumes scanning the interface. Up to four data bytes can be transferred serially by byte in one data-transfer operation.

Selection of the next device (2703, card reader, etc.) is on a priority basis. However, the same 2703 is again selected if any line attached to this unit requires service, and no higher-priority

machine on the channel interface is selected. Usually the 2703 is attached to the multiplexer in the position of highest priority.

The multiplexer channel initiates an operation to a 2703 during the CPU execution of a Start I/O instruction. The specific 2703 operation desired is defined in the channel-command word (CCW). Data transfer in either direction across the I/O interface is initiated by the I/O device after it is commanded to start by the program.

## I/O Instructions

The System/360 operates with the 2703 through the following I/O instructions: Start I/O, Halt I/O, and Test I/O.

### Start I/O

A start I/O instruction executed by the CPU causes initial command selection and the transfer of a command byte to the 2703. Command chaining within the multiplexer channel also causes selection and transfer of a command to the 2703. However, the 2703 will not signal Control Unit Busy status in response to a command cycle resulting from command chaining. This interlock is effected by presenting unit status to the multiplexer channel only if the 2703 is free to accept a possible chained command.

During initial selection, the 2703 loads the line address and the command byte into registers. The 2703 can make the following status responses to Start I/O:

1. If the command is acceptable to the 2703, an all-zero status byte is sent to the channel.
2. If the command is not acceptable to the 2703, Unit Check is returned to the channel and the reason for responding with Unit Check (Command Reject or Bus-Out Check) is set in the sense byte stored in MCW-2.
3. If the 2703 is busy, it signals Control-Unit Busy to the multiplexer channel. Control-Unit Busy is defined for the 2703 as the busy, status-modifier, and control-unit-end bits being ON in the status byte transferred to the channel.

NOTE: This condition occurs only in cases where the channel traffic is exceptionally high.

### Halt I/O

Once the 2703 has responded to initial command selection, the channel can signal Halt I/O. When the 2703 detects a Halt I/O, it loads the line address into a register, the same as for Start I/O. The addressed MCW is commanded to halt. When the current com-

mand at the addressed MCW is terminated, the proper status information is returned to the channel. If the current command is Write, the character being transmitted and the character buffered, if present, are sent before Channel End and Device End status are presented to the channel. A maximum three-character delay (up to 500 ms) can occur between the time the Halt I/O is accepted and the presentation of Channel End and Device End status to the channel.

#### Test I/O

The 2703 responds unconditionally to an all-zero command byte during initial command selection with the status-modifier bit of the status byte. Any existing interrupt conditions in the 2703 are not cleared; the multiplexer channel remains unchanged.

### PROGRAMMING CONSIDERATIONS

From a programming standpoint, the 2703 appears as a number of individual communications-control devices. When an operation or sequence of operations is to be performed, the programmer prepares a list of one or more channel-command words (CCW's) in main storage. (Refer to "System/360--I/O Operation" earlier in this manual for the format of the CCW.) The channel-command word specifies:

1. The command (operation) to be performed (Write, Dial, Read, etc.).
2. The number of bytes contained in the record.
3. The address in main storage where data is to be placed when receiving, or the address of the first byte to be transmitted when sending.
4. Command flags to control possible modification in command execution. The flags are: chain data, chain command, suppress length, skip, and program-controlled interruption.

When the CCW's have been formed, the programmer specifies the channel and line address of the communications line. The execution of a Start I/O instruction causes the command, count, data-address, and control information to be stored in a specified subchannel within the multiplexer channel. The channel then selects the 2703 and relays the command and line address to it; the 2703 accepts the command if valid. The channel then indicates successful or unsuccessful execution of the Start I/O instruction to the program.

Once a command has been accepted by the multiplexer channel and the 2703, the CPU program is unaware of the continuance of the operation until the message has been received or transmitted, or until the multiplexer channel requires interruption either to perform functions such as dynamic storage allo-

cation or because an unusual condition is detected during execution. Since the multiplexer channel contains all the necessary information pertaining to the current operation, data transfer between main storage and the 2703 can be overlapped with CPU processing. The extent of the overlap varies, depending on the processor model (30, 40, 50, 65, or 75) of System/360.

If the 2703 is reset, either by a general system reset, by a power-on reset, or individually at the CE panel, the communications line must be enabled by issuing the Enable command where necessary. This command must be issued before transmitting in all cases except for a link using a half-duplex data set or an IBM Line Adapter.

The following 2703 functions require special programming considerations:

1. The 2703 signals Control Unit Busy in response to initial selection when the interface registers are in use with a previous command cycle or when the 2703 is executing a machine reset resulting from a system reset or power-on reset. The 2703 responds to the interface signals, Address Out and Select Out, and to a valid address on Bus Out with the interface tag, Status In, and to the busy, status-modifier, and control-unit-end bits on Bus In.
2. On an end-of-transmission sequence, when a © is sent under the Write command to a private line using a common-carrier data set with an IBM Terminal Control Type I or II, at least two additional consecutive © 's must be sent by the program. This prevents receiving a false start bit, generated by the remote data set, when the terminal turns off its Request to Send lead.

#### Automatic Wraparound

The automatic-wraparound (autowrap) capability is a standard feature of the 2703 and can be utilized by the program to determine the source of error for a given 2703 line. The wraparound function is initiated by issuing the Wrap command to the 2703 line address on which trouble is suspected.

The 2703 wraps the output of the line to which the Wrap command is issued to the input of the line with the lowest address within this 2703. Wraparound is accomplished within the line adapter to avoid line-termination mismatches, since the line with the lowest line address is not necessarily the same type of line as the line being tested. The execution of Wrap is always one way; that is, the transmit operation is performed on the line in question and the receive operation on the lowest line address. A Read command must be issued to the low line address be-

fore autowrap is started in order to permit the data transmitted by the Wrap command to be received.

The program must ensure that normal operations on the low line have been completed before issuing Wrap to any communications line on the 2703. The program must not issue Wrap to more than one communications line at a time. The program can make a character-by-character comparison of received data with transmitted data and/or monitor the operation for recognizable control characters.

The low line is not reserved as a test line, but is used during the autowrap process. (However, it should be recognized that the low line itself can never be issued a Wrap command.) Since the low line is used with all wraparound operations, the autowrap operation selects the proper terminal control so that this low line operates as if it were the same kind of communications line as the line being tested. In this way, a complete check is made of the common controls and storage as well as the terminal control of the line in question. Receive operations are checked because a common terminal control performs the work.

NOTE: Output data can be blocked from going onto the communications line by issuing the Disable command to the 2703 line just before the Wrap is issued.

### 2703 Common Controls

The common-controls-and-storage section of the 2703 contains the storage and controls that are common to all lines and line bases (see Figure 3). Common controls stores the I/O commands and data bytes, assembles the line-base data bits into characters, and disassembles characters in to line-base data bits.

Four 36-bit words are reserved for each possible line address. These words are:

- Main Control Word 1 (MCW-1)
- Main Control Word 2 (MCW-2)
- Main Data Word 1 (MDW-1)
- Main Data Word 2 (MDW-2)--used exclusively for synchronous operation

The main control words contain the control information necessary for the 2703 to know exactly where it is when sequencing through its operations. They also store status and sense information. The main data words each provide four character buffers for data transfer to and from the channel. These control and data words (Figure 4) allow the 2703 to multiplex the operation of up to 176 transmission lines with one transmission control unit.

The field assignments within the control words differ slightly between start/stop and synchronous type operations as indicated by Figure 4. These differences are described under MCW-1 and MCW-2.

The field assignments for the data words are identical for both types of operation.

### Main Control Word 1

MCW-1 stores the operating controls for its associated line and the data character that is being assembled or disassembled.

Assemble/Disassemble Field. The assemble/disassemble (A/D) field stores the data byte being transmitted or received. Data in the A/D field can be shifted left one bit position at a time.

On a receive operation (for start/stop), the bits in the A/D field are shifted left one position, and the line-base data bit is inserted into bit-position 7.

On a transmit operation (for start/stop), the high-order bit of the A/D field character is sent to the line base, and the A/D bits are shifted left one position.

On a timeout operation, the A/D field is used as a count field. A timeout operation counts time between characters. For example: The 2703 is receiving text from a 1050 terminal and the 1050 operator fails to send EOB (end of block) following the last character; a timeout operation allows the 2703 to end the receive operation 28 seconds after receiving the last character.

For synchronous type operations, bits 4 and 5 within the A/D field are used for data-check and overrun indication when receiving in intermediate-block (ITB) mode. These conditions are set in the error-indicator byte (EIB) following an ITB, ETB (end of transmission block), or ETX (end of text) generated by the 2703 while executing the Read command in ITB mode. Data check can also be set while the 2703 is monitoring the line in the absence of a command, so that once a command is accepted the data-check bit is set in the sense byte within MCW-2. During a transmit operation the A/D field acts as a character buffer, buffering the next character to be transferred to the Synchronous Line Base for transmission.

Character Address. In a Read command this address refers to the position in the MDW to which the A/D field will be transferred when a character has been assembled. Similarly, in a Write operation, this address refers to the next character to be taken from the MDW-1, or MDW-2, and placed in the A/D field.

Bit Count. This counter increments as the A/D field obtains more bits from the start/stop line base, or sends bits to the start/stop line base. When this count reaches a specific number set by the terminal





control, the data in the A/D field is transferred to the MDW-1, or MDW-2, during a Read operation; or, during a Write operation, the data in MDW-1, or MDW-2, is transferred to the A/D field. This counter ensures that each line in the 2703 never requests data service in less than two character times, for any synchronous operation.

For synchronous operations this counter is also used for counting the time between Write commands while in transparency. In addition, it is used during receiving to count for the one-second and three-second receive timeouts.

Timeout. The timeout bits are set during a line timeout and define the type of timeout condition occurring.

Shift. The shift bit indicates an upper-case character in the A/D field. It is set to ON when the A/D field receives a shift character or transmits a character with a shift bit. This field is assigned as an additional position in the mode field for synchronous type operations.

Mode. The mode bits indicate whether the associated line is in text-out, text-in, poll, control, transparent, or intermediate-block mode.

Sequence. The sequence field defines the operation to be carried out on the character in the A/D field. For synchronous operations, this field is extended to four bits by assigning bit 24 as part of this field.

IBM. This is used only for synchronous operations to indicate when the line is in intermediate-block mode. A Set Mode command turns this ON, and it is reset by either a Disable command or by another Set Mode command when the Bus Out-one position is zero.

Command. The command field stores the program commands in abbreviated form (the five low-order bits modified from the command, see Figure 7).

Data Service. The data-service bit signals the I/O-interface circuits to transfer data bytes between MDW-1, or MDW-2, and the multiplexer channel.

During a transmit operation, data service is set for MDW-1 when the last character leaves MDW-1 (for start/stop operations). For synchronous operations, MDW-1 is set for data service when the first character leaves MDW-2, while MDW-2 is set for data service when the first character leaves MDW-1. During a receive operation, data service is set when MDW-1, or MDW-2, contains four data bytes (or fewer, on end-of-operation).

End. The end bit signals the I/O interface to send the ending-status byte to the multiplexer channel.

Halt/Stack. The halt/stack bit indicates one of the following has occurred:

1. The line has received a Halt I/O command from the channel during a transmit operation.
2. The line has received a Halt I/O command or a Stop signal from the channel during a receive operation.
3. The channel was unable to accept either the initial- or the ending-status byte and has requested that status be stacked.

This bit indicates a Halt I/O when the end bit is OFF, and it indicates Stack when the end bit is ON.

Receive. The receive bit is turned ON when the 2703 is receiving data on the associated transmission line.

Parity. This bit is set to provide odd parity for MCW-1.

## Main Control Word 2

MCW-2 (see Figure 4) stores the check character, sense byte, and status byte for its associated line.

LRC Check Character. The LRC-check-character field holds the check character as it is being developed during data transmission. For synchronous operations, this field is unassigned.

Sense Byte. The sense-byte field contains the sense information to be presented to the channel upon receipt of a Sense command. (See "Sense-Byte Conditions" under "Commands.")

Status Byte. The status-byte field contains the ending-status information that is presented to the channel at the completion of the command. (See "Status-Byte Conditions" under "Commands.")

Word-Parity Indicator. This bit is set when a parity error is detected during an access to MCW-2. When this bit is ON with Channel End and Device End, it is reset; Equipment Check is then set to indicate the occurrence of a core-storage parity error.

Parity. This bit is set to provide odd parity for MCW-2.

#### Main Data Words 1 and 2

MDW-1 and MDW-2 (see Figure 4) store the data bytes for receive or transmit type operations. Data is transferred to and from the channel in bursts of up to four bytes to reduce I/O-interface time. MDW-2 is employed only when synchronous type operations are performed.

Data Byte. The eight data-byte fields store the channel data bytes.

I/O Character Count. The character-count field defines the number of characters received from the channel on a transmit data service, or the number of characters to be sent to the channel on a receive data service. The character count in conjunction with the condition of the data bit (ON or OFF) indicates the full or empty condition of the main data words for a transmit operation.

Data. The data bit is set ON if data is stored in MDW-1 for a transmit operation. The data bit ON with a character count of 3 means MDW-1 is full. The data bit OFF with an I/O character count of 3 means there is no data in MDW-1. The same is true for MDW-2. The data bit is not used for receive-data operations.

Parity. This bit is set to provide odd parity for each main data word (MDW-1 and MDW-2).

#### SPECIAL FEATURES SUMMARY

Following is a summary of all special features offered for the 2703. These features are listed in three distinct groups: general--pertaining to both start/stop and synchronous type operations; start/stop type operations exclusively; and synchronous type operations exclusively. The feature number is provided with each feature as a means of positive

identification, as well as for future reference purposes.

In addition, the features within the general group are described in detail. For detailed information pertaining to features exclusive to either start/stop or synchronous operations, check the special-features paragraphs in the start/stop and synchronous portions of this manual.

#### General (both Start/Stop and BSC)

Autocall, first--#1340 (Automatic calling for eight lines)

Autocall, second--#1341 (Automatic calling for an additional eight lines)

Two-Processor Switch--#8110 (Permits two System/360 processors to share one 2703)

#### Start/Stop Type Communications

##### Terminal-Control Features

IBM Terminal Control Base--#4619 (for Terminal Control Type I and II)

IBM Terminal Control Type I--#4696 (for 1050, 1060, 1070, 2740/2741)

2741 Break--#8055 (for 2741 with Interrupt feature)

IBM Terminal Control Type II--#4697 (for 1030)

Telegraph Terminal Control Base--#7905 (for Telegraph Terminal Control Type I and II)

Telegraph Terminal Control Type I--#7911 (for AT&T 83B2/83B3 or Western Union Plan 115A terminals)

Telegraph Terminal Control Type II--#7912 (for Model 33/35 TWX stations)

Telegraph Attachment--#7876 (to attach Telegraph Line Sets)

##### Line-Base Features

Start/Stop Base Type I--#7505 (88 HDX--180-bps maximum)

Start/Stop Base Type II--#7506 (24 HDX--600-bps maximum)

Base Expansion--#1440 (to attach more than one Start/Stop Base Type I or II)

##### Line-Set Features

Data Line Set--#3205 (eight lines using common-carrier data sets--for 1030, 1050, 1060, 1070, 2740, 2741, and Model 33/35 TWX stations)

Data Line Set Expander--#3206 (eight additional lines)

IBM Line Set 1A--#4686 (eight two-wire IBM Line Adapters for up to 4.75 miles--for 2740/2741)  
 IBM Line Set 1B--#4687 (eight four-wire IBM Line Adapters for up to 4.75 miles--for 2740/2741)  
 IBM Line Set 2--#4688 (eight two-wire IBM Line Adapters for up to 8 miles--for 1030, 1050, 1060, 1070, 2740/2741)  
 Telegraph Line Set--#7897 (eight lines for leased common-carrier private-line telegraph service--for AT&T 83B2/83B3 and Western Union Plan 115A terminals, or 1050 terminals)  
 Telegraph Line Set Expander--#7898 (eight additional lines)

#### Speed Options

Line-Speed Option (Start/Stop):

- 45.5 bps--#4873 (common-carrier telegraph service)
- 56.9 bps--#4874 (common-carrier telegraph service)
- 74.2 bps--#4875 (common-carrier telegraph service)
- 75 bps--#4876 (1050 via telegraph channels)
- 110 bps--#4877 (common-carrier TWX)
- 134.5 bps--#4878 (1050, 1060, 1070, 2740/2741)
- 600 bps--#4879 (1030, 1070)

#### 2712 Attachment Features

- 2712 Attachment--#8043 (for Model 1 and/or 2)
- 2712 Model 1 Adapter--#8047 (for eight lines to a 2712 Model 1)
- 2712 Model 1 Expander--#8048 (for two additional lines)
- 2712 Model 2 Adapter--#8057 (for eight lines to a 2712 Model 2)
- 2712 Model 2 Expander--#8058 (for six additional lines)

#### Synchronous Type Communications (BSC)

##### Terminal-Control Features

Synchronous Terminal Control:

- EBCDIC code--#7715
- USASCII code--#7716
- Six-Bit Transcode--#7717
- Station Selection--#7473 (required for any BSC-equipped 2703 using a leased line and operating as a remote--tributary--station in a centralized multipoint network)

#### Line-Base Features

- Base Expansion--#1440 (permits use of the Synchronous Attachment)
- Synchronous Attachment--#7702 (permits attachment of communications lines for synchronous operation)
- Synchronous Base Type IA--#7703 (up to 24 lines for Synchronous Terminal Control using either EBCDIC or USASCII)
- Synchronous Base Type IB--#7704 (up to 16 lines for Synchronous Terminal Control using Six-Bit Transcode, EBCDIC, or USASCII)

#### Line-Set Features

- Synchronous Line Set--#7710 (up to four lines of voice-grade quality for synchronous operation)
- Synchronous Clock--#7705 (for attachment of Western Electric Data Sets 202C1 or 202D1 or equivalent)

#### Speed Option

- Synchronous Line Speed Option--#7711 (provides either of two line speeds available for each Synchronous Clock, either 1200 bps or 2400 bps)

#### Feature Limitations per 2703

Combinations of the following features may not exceed a total assigned weight of nine per Start/Stop Base Type I or II (#7505, 7506) and of six per Synchronous Base Type I (#7703, 7704). Due to this limitation, three Start/Stop Base Type I's may have to be ordered with some configurations.

<u>Feature</u>	<u>Assigned Weight</u>
Data Line Set (#3205)	1
Data Line Set Expander (#3206)	0
Telegraph Line Set (#7897)	1
Telegraph Line Set Expander (#7898)	0
IBM Line Set 1A (#4686)	1
IBM Line Set 1B (#4687)	1
IBM Line Set 2 (#4688)	2
2712 Model 1 Adapter (#8047)	2
2712 Model 1 Expander (#8048)	0
2712 Model 2 Adapter (#8057)	2
2712 Model 2 Expander (#8058)	0
Synchronous Line Set (#7710)	1
Synchronous Clock (#7705)	1

## Autocall Feature

The Autocall (automatic calling) special feature provides the 2703 with automatic dial-up capability under the programmer's control. Each Autocall feature services up to eight dial connection lines, one at a time, on a time-shared basis. A maximum of two Autocall features is permitted with any one 2703.

When either of the Autocall features is used with a Synchronous Line Set, the Autocall feature can accommodate two such line sets (eight BSC lines). However, any such Synchronous Line Sets that share an Autocall feature must adhere to the following:

1. Both Synchronous Line Sets must be on the same Synchronous Line Base;
2. Both must have consecutive addresses;
3. The first Synchronous Line Set of the two must have its initial address assigned to an address boundary that is a multiple of eight.

The programmer initiates the automatic-calling function when he issues a Dial command to an appropriate 2703 line address. On acceptance of the Dial command, the bytes (dial digits) are received from the multiplexer channel in the same manner as any other bytes of output data, and are transferred to common-carrier dial equipment. The dial digits transferred from the multiplexer channel to the 2703 have the following hexadecimal code representation:

<u>Dial Digit</u>	<u>Hexadecimal Code</u>
1	01
2	02
3	03
4	04
5	05
6	06
7	07
8	08
9	09
0	00

NOTE: The 2703 Autocall feature does not check to see that the characters transmitted under a Dial command are valid dial digits.

The dial digits (bytes) continue to be transferred to the dial equipment until the channel signals stop in response to a dial-digit request from the 2703. This terminates the automatic-calling function and frees the Autocall feature to initiate calling on another line.

Command chaining to a Read or Write can be utilized, depending on the terminal type and line-control uses. At completion of the transmission, the call to the remote device is terminated when a Disable command is issued.

Before issuing a Dial command to a dial-access line, a Disable command should be issued to the communications line to prevent the automatic-answering function from being initiated by a terminal. If automatic answering on the line is desired after completion of the transmission initiated by the automatic-calling operation, an Enable command must be issued after the call is terminated.

The time required to establish a connection is determined by common-carrier equipment and may vary significantly. For example, for a 10-digit number--i. e., area code (3 digits), office code (3 digits), and line number (4 digits)--rotary (dial pulse) equipment may require as much as 30 seconds, while pushbutton (tone) dialing equipment may require only 10 seconds.

## Automatic Answering

Automatic answering of incoming calls is standard on any 2703 provided with a Data Line Set or Synchronous Line Set and the appropriate common-carrier data set. This feature permits programmed control over the automatic-answering capability of the 2703. To permit automatic answering of calls, an Enable command must be issued to the appropriate line address. A Disable must be issued to inhibit automatic answering on any line that has been issued an Enable.

Command chaining can be utilized when a call is answered. The command chained to may be either a Read or a Write, depending on the terminal type and line control used (to accept data or to poll the calling terminal). To terminate the call when transmission is completed, a Disable command is issued. To allow further calls to be answered from this line automatically, the Enable command must be reissued.

NOTE: The Autocall feature is not needed or used for the automatic answering of calls on a switched network.

## Two-Processor Switch (TPS) Feature

This special feature allows the 2703 to be attached to the multiplexer channels of two IBM System/360 processors. However, operations can occur with only one processor at a time. The Two-Processor Switch (TPS) may be used in one of three states: neutral, channel "one" attached, channel "two" attached. When in the neutral state, the 2703 monitors both channel interfaces. The TPS is available to the first channel that selects it. When a valid 2703 address is decoded, the entire 2703 attaches to the channel that made the selection. Any signals coming from the unattached channel are bypassed by the 2703 TPS. The address group(s) valid

for attachment to channel "one" may be different from the address group(s) valid for attachment to channel "two."

Only the attached channel can cause the TPS to automatically return to the neutral state. When the switch to the neutral state occurs, the entire 2703 is involved (all lines). This return to neutral may be accomplished by one of two automatic methods:

1. If a system reset is signaled by the attached channel, the TPS unconditionally returns to the neutral state.
2. If a Release command is issued by the attached channel to any of the valid 2703 addresses for that channel and the command is honored, the TPS returns to the neutral state. To honor the Release command, the 2703 must be "command-free" (no line executing a command). If it is not command-free, it will respond to initial selection by setting Channel End, Device End, and Unit Exception and will not go to the neutral state (see Note 2).

Two manual methods whereby the operator may switch to the neutral state through manual intervention are:

1. A power-on reset, initiated by pressing the Power-On pushbutton, causes the TPS to unconditionally return to the neutral state.
2. If the Meter switch on the operator's panel is switched to the OFF position, the TPS causes the 2703 to go off-line only when the attached CPU is in a halt or wait state and the 2703 is command free. After going off-line, the TPS returns to the neutral state. If the TPS is in a neutral state, the 2703 will become unavailable when both CPU-1 and CPU-2 come to a wait state and the meter switch is in the OFF position. While

the Meter switch is in the OFF position, the TPS cannot be set to an attached state with either channel. When the Meter switch is ON, the 2703 will go on-line when both CPU-1 and CPU-2 are in a halt or wait state.

The TPS feature is activated by two manually operated partition switches on the operator's panel (CPU-1 ON/OFF and CPU-2 ON/OFF). These switches permit the operator to initiate a partition (cutoff) of either processor. These switches can be operated for partitioning at any time, but are effective only when:

1. The 2703 is in neutral state.
2. The CPU reaches a halt or wait state, with the partition switch for the CPU to be partitioned (CPU-1 or CPU-2) set to OFF.

NOTES:

1. If both CPU-1 and CPU-2 are partitioned, the 2703 is effectively off-line relative to system availability.
2. The 2703 requires a variable length of time from the sending of the ending status condition to the channel, until detection of the command free state is accomplished. The maximum time period required for detection of the command free state is influenced by the type of Start/Stop base installed in the 2703, as follows:
  - Start/Stop Base Type I--11 ms. max.
  - Start/Stop Base Type II--4 ms. max.If the Release command is presented to the 2703 too soon following the execution of the last command, the Release command will not be honored, since the 2703 will appear to the program as not being command free. In addition, Release should be issued under a unique Start I/O instruction with no command chaining.

The following introduction to start/stop (asynchronous) type operations uses as examples IBM type terminals, such as the 1030, 1050, 1060, and 2740. The transmission of data by means of start/stop type communications involves, for example, the coding of each character with a start bit and a stop bit, in addition to the data bits and possibly a check bit for odd parity such as shown in Figure 5. Thus, the transmission of characters can occur at an irregular rate, since each character contains its own sync information (character timing). This is particularly useful for transmission from unbuffered units such as keyboards and devices requiring the manual insertion of input documents (badge readers, card readers, etc.).

Start/stop communications require the use of a unique set of line-control characters to provide for communications-line discipline (polling and addressing) and identification of the various portions of the message (station identification, text blocks, etc.).

All messages are transmitted during text mode, after certain control operations are first performed in control mode. All characters transmitted during text mode are either printable data characters or functional characters (not printable). The functional characters consist of such codes as CR/LF, delete, and idle.

Codes transmitted during control mode provide terminal control, station identification, and component selection for the remote terminal. For example, the 1050 uses a line-control signal, © --EOT, and an alphabetic station-identification character and a numeric component-select code (together with the appropriate response) to maintain communications-line discipline. These polling and addressing procedures allow the 2703 to control the communications line at all times. Messages transmitted from the 2703 are preceded by an address. Remote stations have the opportunity to transmit only when polled from the 2703.

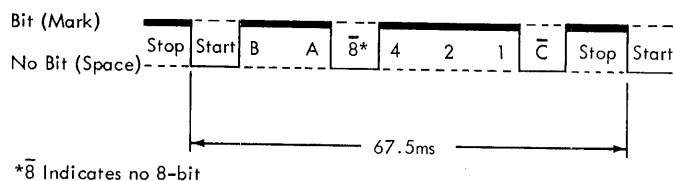

Figure 5. Bit Configuration of a "G" Character (Serialized)

LINE CONTROL

The following are transmitted during control mode:

- Control signals--EOT, EOA, EOB, Yes, No, SOA, and Inquiry.
- Polling characters--These consist of an alphabetic station-identification character, A-Z, followed by a numeric component-select character (used by the 1050), 5, 6, 7, or 0. The polled terminal is requested to transmit, if the polled component is ready.
- Addressing characters--These also consist of an alphabetic station-identification character, A-Z, followed by a numeric component-select character (used by the 1050), 1, 2, 3, 4, or 9. The addressed terminal is requested to receive, if the addressed component is ready.

The line-control signals--EOT, EOA, EOB, Yes, No, SOA, and Inquiry--are represented in a shorthand form-- © , ① , ② , ③ , ④ , ⑤ , and ⑥ , respectively (Figure 6). This form is used in programming as well as in communications and line-control discussions. Also, the terms "response" and "answer" are used in the following restricted manner:

1. Answer--The negative or positive reply, or no reply at all, to an LRC compare.
2. Response--The negative or positive reply, or no reply at all, to a component-select character (addressing or polling).

Description	Symbol	Processor Bit Configuration	Processor Character
End of Transaction (EOT)	©	C-8-4-2-1	√ (Tape Mark)
End of Address (EOA)	①	8-2-1	# (Pound Sign)
End of Block (EOB)	②	C-A-8-4-2	‡ (Record Mark)
Positive Response (YES)	③	B-A-8-2-1	. (Period)
Negative Response (NO)	④	B	- (Hyphen)
Address Select (SOA)	⑤	C-A-8-2-1	, (Comma)
Positive Response (Inquiry)	⑥	8-2-1	# (Pound Sign)

Figure 6. Line-Control Characters

### EOT (End of Transmission)-- ⓐ

- Indicates an end of message transmission, and resets the LRC counters at both sending and receiving stations.

NOTE: LRC does not apply to the 1030 or to the 2740 (without the checking feature installed).

### EOA (End of Address)-- ⓑ

- Indicates the transmission of text data is to follow.
- Indicates an end of address, with text data to follow. This signal starts the LRC counter at both the sending and receiving terminals. The EOA signal is not included in the following LRC check.
- Indicates positive response to a poll from the 2703.

### EOB (End of Block)-- Ⓒ

- Indicates the end of a unit block of text. This is followed by the LRC character to provide an LRC check comparison at the receiving station with the EOB character included in the check.

### Yes (Positive Response)-- ⓓ

- Indicates a positive response to an address.
- Indicates a positive answer to an EOB when the checking feature is installed.

### No (Negative Response)-- Ⓔ

- Indicates a negative response to an address.
- Indicates a negative response to a poll.
- Indicates a negative answer to an EOB; the hyphen character is printed as an indication of this condition.

### SOA (Start of Address)-- ⓔ

- Indicates a start-of-station-identification condition (not used with the 1050).

### Inquiry (Positive Answer)-- ⓕ

- Indicates a positive answer to an EOB from the terminal. At this time, the terminal switches to receive status.

## TRANSMIT OPERATION (WRITE COMMAND)

The transmit operation is initiated when the 2703 accepts a Write command from the multiplexer

channel. Before transmission to the terminals occurs, the transmission control requests the first four bytes of data from the multiplexer channel. These bytes are then transmitted on a bit-by-bit basis to the terminal. Additional requests for four more bytes of data are made each time the last byte is being transferred, until the complete message has been transmitted.

The four bytes of data are stored in the main data word (MDW-1, see Figure 4) located in the 2703 magnetic-core storage. From there they are transferred byte-by-byte to the main control word (MCW-1) for that line. The transfer from the control word in core storage to the line base is accomplished on a bit-by-bit basis until the character has been sent. Each bit is buffered in the line-base delay line. The byte, while in magnetic-core storage circuitry, is shifted one bit position toward the high-order bit before the delay line is loaded. When a character has been sent, the next byte is requested from the data-word location. When the data word is emptied, a request for the next four bytes is sent to the multiplexer channel. This is repeated until the operation is ended.

## RECEIVE OPERATION (READ COMMAND)

The receive operation is initiated when the 2703 accepts a Read command from the multiplexer channel. On detection of a start bit, the transmission control prepares to receive a data character. Before each bit is put into the low-order bit position of the serial-data field, the field is shifted forward one bit position in the high-order direction. Each bit of the character is received in this manner until the terminal control signals stop time to the common controls. Stop time occurs when the bit count equals X, which is a number preset in the terminal control and defined by the number of bits in a character. For example, X is 7 for the IBM Terminal Control Type I. At stop time, the character stored in the main control word (MCW-1) is transferred to the appropriate main data word (MDW-1). The 2703 requests data service when the fourth character has been assembled, and simultaneously prepares to receive the next character.

During the receive operation the common-controls-and-storage section of the 2703 (see Figure 3) provides a timeout of 28 seconds or less between data characters, provided a Read or Search command has been accepted by the 2703. The timeout process is interrupted by a received start bit and is reset and restarted at the following stop time. If the timeout completes before a start bit is received, the Read or Search command is terminated.

Timeout may also result if a terminal indicates an intention to send data after being polled and then fails



to send. When the poll is terminated, the 2703 is commanded to read from the terminal that responded. If the terminal fails to respond within approximately two or three seconds (depending on the terminal), a timeout is recorded, and the Read command is terminated.

## COMMANDS

The command code in the channel-command word (CCW) specifies to the multiplexer channel and the 2703 the operation to be performed. The following stored commands (see also Figure 7) are valid to the Start/Stop Line Bases Type I and II of the 2703. These commands are classified into three groups--transmit-type commands; receive-type commands; and control commands. The groups are identified by the low-order bit positions: transmit-type commands contain 01 in bit-positions 6 and 7 on the channel; receive-type commands contain 10 in bit-positions 6 and 7; and control commands contain 11 or 00 in these bit positions. The "Sad" ("Set Address") commands (e. g., Sadzer) are classified as exception commands and used only by the 2702. When any of these commands are received by the 2703, they are treated as an I/O No-Op.

NOTE: Command chaining should not be used to link two or more segments of a message block together.

### Transmit-Type Commands

#### Write

Bytes are transferred from the channel to the addressed communications line four at a time except at the end of a message (when the channel signals a stop after the message has been completed, or the 2703 terminates the operation). Since the four bytes or code characters are requested by the 2703 each time its MDW-1 needs service, the average data-transfer rate from the channel to the 2703 is determined by the bit rate of the communications facility.

The Write command is accepted, but ended immediately with Channel End, Device End, and Unit Exception status bits, if the 2703 is receiving data from the communications line on this address. Various other unusual ending conditions also set the Channel End, Device End, and Unit Check status bits, as well as a particular bit in the sense field. These are: parity on Bus Out, which will set the Bus Out Check; a VRC Check, an Echo Check, or Break signal received on the appropriate type of line, which will cause the Data Check or Intervention Required sense bit to be set. Finally, if a data set is in a power-off condition, or in test mode, or if

a telegraph line has not been "enabled," the Intervention Required bit in the sense field is set.

If the data transfer is completed normally, the command is ended with Channel End and Device End status.

#### Wrap

On acceptance of this command, the 2703 wraps the output of the addressed line to the input of the line with the lowest address in the 2703. This command is executed in an identical manner to a Write, and the error conditions are the same.

#### Break

On acceptance of this command, a continuous Space signal is transmitted on the addressed line. Bytes are transferred from the channel to the 2703 to provide control over the length of the Space signal. Each byte causes one character of space to be inserted on the communications line. For example, a terminal operating at 74.2 bps requires about 94 ms per character. Thus, a CCW count of ten causes a space of 0.94 seconds. These bytes may have any bit configuration. The Break command is valid only for Telegraph Terminal Controls Type I and Type II. On all other lines this command is rejected as invalid.

#### Poll

On acceptance of the Poll command, the 2703 requests a certain number of characters from the channel. (This number is determined by the terminal control for that line.) These polling characters are transmitted and the 2703 goes to receive mode until either a reply is received or a three-second timeout is completed.

If a negative reply is received, the 2703 asks for the next polling characters and continues on in this manner. If, however, a positive reply is received, the 2703 sets Channel End, Device End, and Status Modifier, and the channel chains immediately to a Read command. The Poll command is valid only for the IBM Terminal Controls Type I and II.

In actual operation, the Poll command causes the 2703 to request three characters (two in the case of the 1030) from the channel--the first two being the station address and the third being a count character (any graphic). The 2703 then generates a © and transmits the two address characters from the channel, while buffering the count character. It then turns around and awaits a response from the terminal.

There are four possible responses, each of which causes a different action from the 2703:

Commands		P	0	1	2	3	4	5	6	7	Bit Positions
Transmit	WRITE	0	0	0	0	0	0	0	0	1	
	WRAP	1	0	0	0	0	0	1	0	1	
	BREAK	0	0	0	0	0	1	1	0	1	} Telegraph Terminal Control Type I or Type II
	POLL	1	0	0	0	0	1	0	0	1	
	DIAL	0	0	0	1	0	1	0	0	1	} Autocall Feature
Receive	READ	0	0	0	0	0	0	0	1	0	
	PREPARE	1	0	0	0	0	0	1	1	0	
	INHIBIT	1	0	0	0	0	1	0	1	0	
	SEARCH	0	0	0	0	0	1	1	1	0	} Telegraph Terminal Control Type I
Control	ENABLE	1	0	0	1	0	0	1	1	1	
	DISABLE	0	0	0	1	0	1	1	1	1	
	SENSE	0	0	0	0	0	0	1	0	0	
	I/O NO-OP	1	0	0	0	0	0	0	1	1	
	RESERVE	0	1	1	1	1	0	1	0	0	} Two Processor Switch Feature
	RELEASE	1	1	1	0	1	0	1	0	0	
Exception	SADZER	0	0	0	0	1	0	0	1	1	
	SADONE	1	0	0	0	1	0	1	1	1	
	SADTWO	1	0	0	0	1	1	0	1	1	
	SADTHREE	0	0	0	0	1	1	1	1	1	

Figure 7. Start/Stop Commands

1. Positive response in the form of a **Ⓚ** followed by text.
2. Negative response-- **Ⓝ** .
3. No response.
4. The received character not recognized as either a **Ⓝ** or **Ⓚ** .

The action taken with each response is as follows:

1. Status Modifier is set in the status byte and the command is ended by the 2703. The channel then chains to a Read command and the count character, instead of the **Ⓚ** character, is returned to the channel.
2. The 2703 requests three more characters from the channel and transmits only the first two characters.
3. A three-second timeout is completed and the 2703 ends the command with the Unit Check and Timeout bits set in the status and sense bytes.
4. The command ends with Unit Check and Data Check set in the status and sense bytes. In some cases Intervention Required is set; refer to "Sense-Byte Conditions" later in this portion of the manual.

NOTE: Any time the 2703 receives a negative response to a Poll command, the polling operation is continued without interrupting the CPU.

## Dial

On acceptance of the Dial command by the 2703, bytes are transferred through the Autocall Adapter to the automatic-calling equipment. They are, however, transferred from the channel to the 2703 up to four digits at a time, in keeping with the normal transfer of data. This command is very similar to a Write command, except that the characters are transferred to the Automatic Calling Unit rather than a data set. The error conditions are identical to the Write command except that Equipment Check indicates a failure of the 'call request' latch rather than a transfer check of the 'transmit data' latch.

## Receive-Type Commands

### Read

Bytes are transferred from the line to the channel each time the MDW-1 is filled with four characters, or at the end of a message. The terminal controls provide for deletion of control characters (up-shift, down-shift, idle, and delete) from the incoming message. This command is terminated at the end of a message by setting of Channel End, Device End, and Unit Exception bits in the status

field. These bits are set when the 2703 receives a **Ⓚ** from the communications line while in text mode. When in control mode, either a **Ⓚ** , or **Ⓝ** (only for IBM Line Sets), causes the Channel End, Device End, and Unit Exception bits to be set. Otherwise, the command is ended normally with Channel End and Device End. For other ending-status conditions, refer to "Status-Byte Conditions."

### Prepare

This command is normally used in a contention-type communications system to notify the processor when data is arriving. It is also useful to check for the Break signal, to indicate when a Break or elongated Space signal ends (the line returns to Mark). When a valid start bit is detected by a line instructed to Prepare, a character is strobed off. If at stop-bit time the line is at Mark (which indicates the line has returned to the normal idle condition or that a character has been received), the command is terminated with Channel End and Device End status. The character assembled is not transferred to the multiplexer channel. If the line was at Space at stop-bit time, the 28-second line timeout is started. If the line returns to Mark before the timeout is complete, this command is terminated with Channel End and Device End status. If the line does not return to Mark before completion of this timeout, then the Prepare command is terminated (indicating an open-line condition) with Channel End, Device End, and Unit Check status, and the Timeout sense bit is set in the addressed MCW-2.

No data transfer occurs under Prepare, and no characters received during its execution are transferred to the processor (they cannot be recovered). However, line-control characters received under this command continue to be recognized (as they are under Read) and they perform their normal function.

NOTE: To avoid a hang-up condition when operating with the 2741 Break feature or with any telegraph device, a Halt I/O command should be issued immediately following a Prepare command. The Halt I/O command is essentially ignored while the line is still at Space. However, when the line is at Mark, the Prepare command is ended immediately.

### Inhibit

On acceptance, the 2703 performs normal read operations except that idle-line timeouts are inhibited (except during Timeout Sequence, which is performed just before the command ends).

## Search

This command is provided to allow the processor to ignore terminal-to-terminal messages on telegraph lines when using Telegraph Terminal Control Type I (only). That is, a selected (polled) teletypewriter station may address another teletypewriter station on the same line without going through the 2703's processor and without causing channel interference due to data servicing during the body of the message. The Search command is valid for only Telegraph Terminal Control Type I lines.

On acceptance of Search, the 2703 scans the first two non-letters characters received from the line. If the first such character received is "V" (the negative response to polling for 83B2/83B3 and Plan 115 stations), the "V" is transferred to the I/O channel. Timeout Sequence is set in the addressed MCW-1, and the command ends with Channel End and Device End status. If the first two such characters comprise the sequence "AZ" (the processor's own address), then "AZ" is transferred to the I/O channel and the command ends immediately with Channel End and Device End status.

If any other non-letters character is received at the beginning of the message, the MCW-1 monitors the received data for FIGS-H, LTRS sequence (EOT). If this sequence is received, the "H" character is transferred to the processor, Timeout Sequence is set, and the command ends with Channel End, Device End, and Unit Exception status.

NOTE: If the first non-letters character is "A", but "Z" does not follow immediately because another station is being addressed, the "A" is transferred to the I/O channel.

## Control Commands

### Enable

When this command is accepted, the 'enable' latch is set within the line adapter of the addressed communications line. No data transfer occurs. A 28-second timeout is initiated while waiting for the line to become operational, except on a data set that has automatic-answering capabilities.

### Disable

On acceptance of this command, the 2703 resets the 'enable' latch within the line adapter of the addressed communications line. No data transfer occurs.

## Sense

On acceptance of this command, the 2703 returns a single byte to the channel from the sense field in the MCW of the addressed communications line. This byte defines the condition of the addressed communications line.

### I/O No-Op

This command is treated as a "control immediate" and no operation is performed by the 2703. Channel End and Device End are transferred in the status byte. No access is made to the 2703 storage unless the multiplexer channel stacks the status response. This command does not reset the sense field.

### Reserve

The Reserve command is valid only when the Two-Processor Switch (TPS) feature is installed. This command is used to achieve attachment to the channel via the TPS feature. The Two-Processor Switch must be in a neutral state at this time. Once attachment to a channel is achieved, the Reserve command is treated as an I/O No-Op, with the setting of Channel End and Device End status.

### Release

This command is valid only when the TPS feature is installed. If a Release command is issued by the attached channel to any of the valid 2703 addresses for that channel, and the command is honored, then the TPS returns to the neutral state. The 2703 must be command-free to honor this command.

## Exception Commands

Sadzer, Sadone, Sadtwo, Sadthree

These are standard 2702 commands, each of which is treated as an I/O No-Op when decoded by the 2703. These commands are accepted by the 2703 to permit programming compatibility between the 2702 and the 2703.

## STATUS-BYTE CONDITIONS

A status byte provides an indication to the processor of the specific condition of the 2703. The status byte is automatically sent to the channel: (1) as a status

response by the 2703 each time a command is received and before use of this command by the 2703; and (2) following the completion of each command. The status byte informs the CPU program of the 2703 status for the initial-selection sequence as well as following the termination of each 2703 command operation.

Initial-Status Conditions

The 2703 responds to initial command selection by always sending a status byte to the multiplexer channel with the following exceptions:

1. Power is down on the 2703.
2. The 2703 is off-line for testing.
3. The 2703 is equipped with the Two-Processor Switch feature and selection is attempted by the inactive processor when the TPS is not in the neutral state.
4. The 2703 machine clock has failed.
5. The 2703 is not metering because the 2703's Meter switch on the operator's panel is in the OFF position.
6. The address coming from the multiplexer channel has incorrect parity.

Any of the following status conditions can be presented to the multiplexer channel during the initial-selection sequence.

All Zeros (Normal)

This status is set in response to operations initiated by a Start I/O instruction or command chaining, and indicates that the 2703 has accepted a command.

Busy, Status Modifier, and Control Unit End

This status indicates a temporary 2703 Control Unit Busy. The 2703 is also busy for 5.1 ms when performing a general reset. This status is also indicated when the 2703 is updating the MCW-1 and MCW-2 after Start I/O.

This status will not be indicated by the 2703 if it is possible for the channel to command chain.

Unit Check

This status is set in response to operations initiated by a Start I/O instruction; it indicates that the command issued to the 2703 will not be executed because it is invalid or has improper parity. This condition is further defined by the sense byte.

Status Modifier

This status serves an an unconditional response to a Test I/O instruction.

Channel End and Device End

This status serves an an unconditional response to the I/O No-Op, Sadzer, Sadone, Sadtwo, and Sadthree commands.

Ending-Status Conditions

The following status conditions can be presented to the channel at the end of a 2703 command execution.

Channel End and Device End

This status indicates that the current command has been brought to a normal end and the 2703 is free to accept another command.

NOTE: These two conditions always appear together in the 2703 as a single status condition.

Channel End and Device End status has special meaning for the following commands:

**Enable or Dial** When either of these commands is issued to a line in a switched network (attached to the Western Electric Data Set 103A1, 103A2, or equivalent, this status indicates that the connection to the terminal has been established through the network. This status is indicated if a Halt I/O is issued to a line that is executing Enable and the data set is "off hook" before the 'enable' latch can be reset.

**Prepare** Here this status indicates that the addressed line has started to receive; the line went to Space long enough to be recognized as a true start bit and then returned to Mark (the normal state of the line). However, if this command had been terminated by Halt I/O, this status would indicate that the command was successfully aborted and the line never went to Space.

**Search** Here this status indicates that the first non-letters character(s) received over the addressed line (using Telegraph Terminal Control Type I) was either "V", negative polling response, or "AZ", the processor's address.

**Read** When this command is issued to a line with the Telegraph Terminal Control Type I, this status indicates that the first non-letters character received was "V". "V" is the negative response to polling and the positive response to addressing for AT&T 83B2/83B3 and Western Union Plan 115A terminals.

NOTE: For World Trade operation when using Telegraph Terminal Control Type 1, this status indicates that the End of Block (EOB) signal was received--that is, "FIGS-X" (uppercase X).

### Channel End, Device End, and Unit Exception

The conditions that cause this status to be signaled depend on both the type of line and terminal control involved, as well as the particular command that was issued. It will never be signaled for Disable, Break, or Sense. For the remaining commands, this status indication is influenced by the type of terminal control involved, as follows:

**Read or Inhibit** IBM Terminal Control Type I. This status is signaled if **Ⓒ** (EOT) or **Ⓝ** (negative reply) is received while the addressed line is in control mode and executing either of these commands. It is also set any time a **Ⓒ** is received, providing the 2741 Break feature is not installed.

IBM Terminal Control Type II. This status is signaled if **Ⓝ** is received while the addressed line is executing either of these commands and the line is in control mode. It is also set any time a **Ⓒ** is received.

Telegraph Terminal Control Type I. Operating with 83B2/83B3 and 115A terminals, this status is set if the End of Transmission signal (FIGS-H, LTRS) is received while the addressed line is executing either a Read or Inhibit command. When using this terminal control type for World Trade operation, this status signals that the EOT sequence (FIGS-H, LTRS) was received during execution of either command.

Telegraph Terminal Control Type II. This status means that the EOT character was received while executing either of these commands.

**Search** Telegraph Terminal Control Type I (only). With either 83B2/83B3 or 115A terminals, this status indicates that the EOT sequence (FIGS-H, LTRS) was received while executing this command.

**Write or Poll** This status is signaled if the receive-control bit in the addressed MCW-1 is ON when the command is accepted. The command's execution is terminated immediately.

**Dial** If Halt I/O is signaled during the execution of Dial, before Stop was received from the I/O channel (the entire number has not been dialed), the Dial operation is ended with this status.

**Prepare** If Halt I/O is issued to a line that is executing Prepare, and the line has started to receive (a true start bit was detected) but the ending status has not yet been signaled, then this status is signaled at the normal ending point for this command, after the line returns to Mark.

**Enable** This status is signaled if Halt I/O is issued to a line that is executing Enable and the call has not yet been answered (Data Set Ready is OFF). The 'enable' latch is reset.

**Wrap** This status will be signaled if the receive-control bit in the addressed MCW-1 is ON when the Wrap command is accepted.

### Channel End, Device End, Unit Exception, and Unit Check

The conditions that cause this status to be signaled are a combination of the conditions that cause the command to end with Channel End, Device End, and Unit Exception status plus one or more of the error conditions that cause the sense bits to be set. A Sense command should be issued to the unit address in order to determine the error conditions. The conditions that can be signaled are listed under "Sense-Byte Conditions." This status can be signaled only when ending Wrap, Read, Write, Dial, Prepare, Enable, Inhibit, Search, or Poll.

### Channel End, Device End, and Unit Check

This status indicates that the current command has been ended by an error or an unusual condition. A Sense command must be issued to the addressed unit to further define these conditions.

### Channel End, Device End, and Status Modifier

This status is set for the Poll command when a **Ⓓ** (EOA) character is detected.

### SENSE-BYTE CONDITIONS

The sense byte is transferred to the multiplexer channel only when a Sense command is issued. The various bit positions within the byte are set by

different sense conditions, as indicated by the following chart. The sense byte is assembled within the MCW-2 and transferred to the processor, by way of the multiplexer channel, when requested by the Sense command.

<u>Bit Positions</u> (within Sense Byte)	<u>Sense Conditions</u>
0	Command Reject
1	Intervention Required
2	Bus Out Check
3	Equipment Check
4	Data Check
5	Overrun
6	Lost Data
7	Timeout

Four of these sense bits (2, 3, 5, 6) are set by the common controls independent of the specific terminal control associated with the addressed line. The other four sense bits (0, 1, 4, 7) are associated with the terminal control for the line.

The sense information pertaining to the previous I/O operation is reset by the next command addressed to a line (except for I/O No-Op, Halt I/O, Test I/O, and Sense).

### Common Controls

The various sense conditions are:

#### 2-Bit--Bus Out Check

This bit is set when a parity error is detected on Bus Out. Parity is checked on Bus Out when the command is transferred during initial selection, and when output data (from the channel) is being presented. The command terminates at the normal ending time. The 2703 will not respond to initial selection unless the address on Bus Out has correct parity.

#### 3-Bit--Equipment Check

This bit is set when a check condition has been detected within the 2703. These conditions are:

1. A transfer check of the 'transmit data' latch occurred within a line adapter during execution of Write, Break, Poll, or Wrap.
2. A transfer check of the 'enable' latch occurred during execution of Enable, Dial, or Disable.
3. A transfer check of the 'call request' latch occurred during the Dial command.
4. If a line is in operation and a new command is issued for that line, Equipment Check is

returned and the previous operation will be terminated immediately.

5. A core-storage parity error occurred when a command was present in the line.
6. A delay-line malfunction occurred for all lines of the associated base with a command present.

#### 5-Bit--Overrun

This bit is set under the Read or Inhibit commands during a receive operation, if a byte of data is lost because data service could not be obtained within the one-character interval of the communications line-- that is, if data service is not honored by the channel before the stop bit for the next character is received.

This sense bit is never set while executing any command other than Read or Inhibit.

#### 6-Bit--Lost Data

This bit is set during either a Read, Inhibit, Prepare, or Search command as follows:

1. During a Read command if the command is issued to a line whose data-service bit in the MCW-1 is set. This indicates a loss of data, since the command was not issued within four characters of the time the line became active.
2. Also during a Read command if the data-service bit in the MCW-1 is ON when the line receives a Halt I/O command.
3. If a stop sequence is indicated by the channel while in a read-service operation.
4. During a Read, Inhibit, Search, or Prepare command if the receiving bit in the MCW-1 is ON when a Halt I/O is issued.
5. In case the receiving bit in MCW-1 is ON when a Search is issued.
6. If a Dial command is issued to a line already "off-hook."
7. If the PND (present next digit) lead from the Automatic Calling Unit is ON while the sequence field (in MCW-1) is in the reset state.

All these conditions indicate a possible loss of data.

### IBM Terminal Control Type I

#### 0-Bit--Command Reject

This bit is set during initial selection:

1. By the interface controls if a command that is not defined or cannot be executed by the 2703 is presented. This occurs if the Dial command is issued and the Autocall Adapter has not been installed in the 2703. The Dial command is

accepted, but then rejected if issued to a line not associated with an installed Autocall Adapter.

2. By the common controls if an associated line is issued the Break or Search command. The Break or Search is not executed, but is ended immediately.

This sense bit is never set for the Read, Write, Poll, Prepare, Wrap, Enable, Disable, Inhibit, or Sense commands.

#### 1-Bit--Intervention Required

If a Read, Inhibit, Poll, Write, or Prepare command is being executed and the addressed line has a data line set attached, this bit will be set:

1. If the data set has power off.
2. If the data set is not attached to the 2703.
3. If the data set is either "on-hook" or not in data mode.
4. If the addressed line has a telegraph line adapter that has not been enabled.
5. For the Read, Inhibit, and Poll commands only, if a continuous Space signal is received for one character time or greater.
6. While Dial is being executed, if the ACU (Automatic Calling Unit) Power Indicator is OFF.
7. Also if the ACU is not connected to the 2703.

This bit is never set under the Wrap, Enable, Disable, and Sense commands.

#### 4-Bit--Data Check

This bit is set:

1. During execution of the Read and Inhibit commands if the line is in text-out mode and a  $\text{\textcircled{N}}$  (negative reply) is received; it indicates that the remote terminal received data with incorrect parity or LRC.
2. For the Read, Inhibit, and Poll commands if the line is at Space at stop-bit time (2703 is out of sync).
3. When the line is executing Write, Poll, or Wrap if a VRC error is detected in one of the characters being transmitted.
4. If the line is equipped with the telegraph line adapter and an echo check occurs.
5. During Read, Inhibit, or Poll when a VRC or LRC error is detected.
6. If the response to a Poll command is not  $\text{\textcircled{D}}$ , or  $\text{\textcircled{N}}$ .

This sense bit is not set during the execution of Dial, Prepare, Enable, Disable, or Sense.

#### 7-Bit--Timeout

This sense bit is set:

1. During the execution of the Read command if no characters are received for a continuous period of three seconds while the line is in control mode. For text-mode operation, a 28-second timeout applies.
2. During the execution of Dial, if the ACU's ACR (Abandon Call and Retry) line turns ON. This indicates that the call was not established in the allotted period of time and should be redialed.
3. During a Poll command if no characters are received for a continuous period of three seconds when the receive-control bit is ON.
4. During the execution of a Prepare command if a continuous Space signal has been received for more than 28 seconds.
5. During the execution of Disable if a switched-network data set does not go "off-hook" or "on-hook" within 28 seconds after being signaled to do so. That is, Data Set Ready does not turn OFF and end the Disable command within 28 seconds of the time that Data Terminal Ready turned OFF.

This sense bit is not set during execution of Write, Wrap, Break, Enable, or Sense.

#### IBM Terminal Control Type II

#### 0-Bit--Command Reject

This bit is set during initial selection:

1. By the interface controls if a command that is not defined or cannot be executed by the 2703 is presented. This occurs if the Dial command is issued and the Autocall Adapter is not installed in the 2703. The Dial command is accepted but then rejected when issued to a line not associated with an installed Autocall Adapter.
2. By the common controls if an associated line has been issued the Break or Search command. The Break or Search is not executed but is ended immediately.

This sense bit is never set for the Read, Write, Poll, Prepare, Wrap, Enable, Disable, Inhibit, or Sense commands.

#### 1-Bit--Intervention Required

This bit is set when a Read, Inhibit, Poll, Write, or Prepare command is being executed and the addressed line has a data line set attached:



1. If the data set has power off.
2. If the data set is not in data mode.
3. For the Read, Poll, and Inhibit commands only, if a continuous Space signal is received for one character time or greater.

This bit is never set under the Wrap, Enable, Disable, or Sense commands.

#### 4-Bit--Data Check

This bit is set:

1. During the execution of the Read or Inhibit command if the line is in text-out mode and  $\textcircled{N}$  is received. It indicates that the remote terminal detected a VRC error in the last block of data received.
2. For the Read, Inhibit, and Poll commands if the line is at Space at stop-bit time (the 2703 is out of sync).
3. When the line is executing Poll, Write, or Wrap if a VRC error is detected in one of the characters being transmitted.
4. During a Read, Poll, or Inhibit when a VRC error is detected.
5. If the response to a Poll command is not  $\textcircled{D}$  or  $\textcircled{N}$ .

This bit is not set during the execution of the Dial, Prepare, Enable, Disable, or Sense commands.

#### 7-Bit--Timeout

This sense bit is set:

1. During the execution of the Read command if no characters are received for a continuous period of three seconds when the line is either in control mode or its receive-control bit is OFF. Otherwise, the 28-second timeout applies.
2. During the execution of Prepare if a continuous Space signal is received for a period of more than 28 seconds.
3. During a Poll command if no characters are received for a continuous period of three seconds when the receive-control bit is ON.

This sense bit is not set while the line is executing Disable, Write, Wrap, Enable, Break, Inhibit, Sense, or Search.

#### Telegraph Terminal Control Type I

##### 0-Bit--Command Reject.

This bit is set during initial selection by the interface controls:

1. If a command that is not defined or cannot be executed by the 2703 is presented. This occurs if the Dial command is issued and the Autocall

Adapter has not been installed in the 2703. The Dial command is accepted but then rejected if issued to a line not associated with an installed Autocall Adapter.

2. If a Poll command is issued to a line controlled by Telegraph Terminal Control Type I.

This sense bit will not be set during the execution of the Read, Write, Prepare, Wrap, Enable, Disable, Inhibit, Sense, Search, or Break commands.

##### 1-Bit--Intervention Required

This sense bit is set:

1. To indicate that the addressed line has not been enabled, if the Read, Inhibit, Write, Prepare, Break, or Search command is being executed.
2. If a continuous Space signal is received for one character time or greater during the execution of Read, Inhibit, or Search.

This bit is never set during the execution of the Dial, Wrap, Enable, Disable, Poll, or Sense commands.

#### 4-Bit--Data Check

This bit is set:

1. During the execution of Read, Inhibit, or Search if the line is at Space at stop-bit time.
2. During the execution of Write or Break if an echo check occurs.

This sense bit is not set under the Dial, Prepare, Enable, Disable, or Sense commands.

#### 7-Bit--Timeout

This sense bit is set:

1. During the execution of Read or Search if no characters are received for a continuous period of more than 28 seconds when the receive-control bit is ON, or two seconds if this bit is OFF.
2. During the execution of Prepare if a continuous Space signal has been received for more than 28 seconds.

This sense bit is never set under the Write, Wrap, Dial, Disable, Enable, Break, Inhibit, Poll, or Sense commands.

#### Telegraph Terminal Control Type II

##### 0-Bit--Command Reject

This bit is set during initial selection by the interface controls:

1. If a command that is not defined or cannot be executed by the 2703 is presented. This occurs if the Dial command is issued and the

Autocall Adapter has not been installed in the 2703. The Dial command is accepted but then rejected if issued to a line not associated with an installed Autocall Adapter.

2. For Poll or Search.

This sense bit is not set during the execution of the Read, Write, Prepare, Wrap, Enable, Disable, Inhibit, Sense, or Break commands.

1-Bit--Intervention Required

If a Read, Inhibit, Write, or Prepare command is being executed and the addressed line has a data line set attached, this bit is set:

1. If the data set has its power off.
2. If the data set is "on-hook."
3. If the data set is not in data mode (is in either test or talk mode).
4. If the data set is not attached.
5. For the Read and Inhibit commands only, if a continuous Space signal is received for one character time or greater.
6. If Dial is being executed, if the ACU's Power Indicator is OFF.
7. During the Dial command if an ACU is not attached for this line.

This bit is not set for the Wrap, Enable, Disable, Sense, Poll, or Search commands.

4-Bit--Data Check

This sense bit is set:

1. During the execution of Read and Inhibit if the line is at Space at stop-bit time (the 2703 is out of sync).
2. If the line is executing Write and a Break signal is received over the Received Data line.

This bit is never set under the Dial, Enable, Prepare, Break, Wrap, Disable, Sense, Search, or Poll commands.

7-Bit--Timeout

This sense bit is set:

1. During the execution of the Read command if no characters are received for a continuous period of 28 seconds.
2. During the execution of Dial if the ACU's Abandon Call and Retry line turns ON. This indicates that the call was not established in the allotted time and should be redialed.
3. During the execution of Prepare if a continuous Space signal longer than 28 seconds is received.
4. During the execution of Disable if a switched-network data set does not go "on-hook" within 28 seconds after being signaled to do so. That is, Data Set Ready does not turn OFF and

end the Disable command within 28 seconds of the time Data Terminal Ready turned OFF. This sense bit is not set during the execution of the Write, Wrap, Enable, Break, Inhibit, Poll, or Sense commands.

2741 Break

0-Bit--Command Reject

This sense bit is set during initial selection:

1. By the interface controls if a command that is not defined or cannot be executed by the 2703 is presented. This occurs if the Dial command is issued and the Autocall Adapter has not been installed in the 2703. The Dial command is accepted but then rejected if issued to a line not associated with an installed Autocall Adapter.
2. By the terminal controls if an associated line has been issued the Poll or Search command. The Poll or Search is not executed, but is ended immediately.

This sense bit is never set for the Read, Write, Break, Prepare, Wrap, Enable, Disable, Inhibit, or Sense commands.

1-Bit--Intervention Required

If a Read, Inhibit, Write, or Prepare command is being executed and the addressed line has a data line set attached, this bit is set:

1. If the data set has power off.
2. If the data set is "on-hook."
3. If the data set is not in data mode.
4. If a data set is not attached to the 2703.
5. For the Read and Inhibit commands only, if a continuous Space signal is received for one character time or greater.
6. If, during transmit, a line is at Space for a minimum of two successive characters.
7. If Dial is being executed, if the ACU's Power Indicator is OFF.
8. If the ACU is not connected to the 2703.

This bit is never set under the Wrap, Enable, Disable, or Sense commands.

4-Bit--Data Check

This sense bit is set:

1. During the execution of a Read or Inhibit command if the line is at Space at stop-bit time (2703 is out of sync).
2. When the line is executing Write or Wrap if a VRC error is detected in one of the characters being transmitted.

3. During Read or Inhibit when a VRC error is detected.

This sense bit is not set during the execution of Dial, Prepare, Enable, Disable, or Sense commands.

#### 7-Bit--Timeout

This sense bit is set:

1. During the execution of the Read command if no characters are received for a continuous period of three seconds when the line receive-control bit is OFF. Otherwise, a 28-second timeout applies.
2. During the execution of Dial if the ACU's ACR (Abandon Call and Retry) line turns ON. This indicates that the call was not established in the allotted time period and should be redialed.
3. During the execution of a Prepare command if a continuous Space signal has been received for more than 28 seconds.
4. During the execution of Disable if a switched-network data set does not go "on-hook" within 28 seconds after being signaled to do so.

This sense bit is not set during the execution of Write, Wrap, Break, or Sense.

#### START/STOP SPECIAL FEATURES

The features described here pertain only to start/stop type operation. However, the maximum allowable features (see Figure 3) for a given configuration is influenced by the feature mix for both start/stop and synchronous in the areas of Line Sets, 2712 Adapter, and Synchronous Clock; the "Feature Limitations per 2703" under "Special Features Summary" gives more detailed information.

#### Terminal Controls

One terminal control is required, although as many as six may be chosen (four start/stop and two synchronous) for any 2703 Transmission Control. One terminal control may service all terminals of the same type. The following start/stop type terminal controls are available for use.

#### IBM Terminal Control Type I

A maximum of one per 2703 is permitted. This feature allows for the attachment of:

- IBM 1050 Data Communication System
- IBM 1060 Data Communication System
- IBM 1070 Process Communication System
- IBM 2740 Communication Terminal
- IBM 2741 Communication Terminal (without Interrupt Feature)

IBM Terminal Control Type I also provides VRC and LRC (vertical and longitudinal redundancy check) checking capabilities.

#### 2741 Break Feature

A maximum of one per 2703 is permitted. This feature permits the IBM Terminal Control Type I to operate with an IBM 2741 equipped with the Interrupt feature, thus accommodating various time-sharing applications utilizing the 2741. The IBM Terminal Control Type I is a prerequisite.

This Break feature does not prohibit using the IBM Terminal Control Type I for operation with 1050, 1060, 1070, 2740, and 2741 (without Interrupt feature) terminals.

#### IBM Terminal Control Type II

A maximum of one per 2703 is permitted. This feature allows for the attachment of:

- IBM 1030 Data Collection System, except for the 1032 Digital Time Unit

#### Telegraph Terminal Control Type I

A maximum of one per 2703 is permitted. This feature allows for the attachment of:

- AT&T 83B2/83B3 Selective Calling Stations
- Western Union Plan 115A Outstations

#### Telegraph Terminal Control Type II

A maximum of one per 2703 is permitted. This feature allows for the attachment of:

- Common-Carrier TWX Stations (Model 33/35 Teletypewriter terminals) using 8-level code.

#### IBM Terminal Control Base

A maximum of one per 2703 is permitted. An IBM Terminal Control Base must be specified for the 2703 if the user wishes to include either IBM Terminal Control Type I, or IBM Terminal Control Type II, or both.

#### Telegraph Terminal Control Base

A maximum of one per 2703 is permitted. A Telegraph Terminal Control Base must be specified for the 2703 if the user wishes to include either Telegraph Terminal Control Type I, or Telegraph Terminal Control Type II, or both.

## Line Bases

A Start/Stop Line Base Type I accommodates up to 88 half-duplex lines operating at speeds up to 180 bps; a Start/Stop Line Base Type II accommodates up to 24 half-duplex lines operating at speeds up to 600 bps.

A maximum of three line bases may be attached to any 2703. However, a limitation of 176 lines per 2703 means that if three Type I bases are installed, only 176 lines can be attached for the three bases. The possible combinations available are shown in Figure 8.

### Base Expansion Feature

This feature is required if more than one Start/Stop Base Type I or II is to be installed in the 2703. It is also required whenever a Synchronous Attachment is specified. A maximum of one Base Expansion feature per 2703 is permitted.

## Line Sets

Five types of start/stop line sets are available. Also, seven speed options are available for start/stop. The choice of line set is generally independent of the type of terminal but dependent on the communications facility specified. All lines in a given line set must operate at the same speed and must be associated with the same terminal control. They must also attach to the same type of common-carrier facilities. Table I summarizes the line sets per line base and per 2703. The line sets available are as follows.

### Data Line Set

A maximum of twelve per 2703 is permitted. This feature provides the line terminations for connecting to eight common-carrier-supplied data sets per feature. The following data sets (or equivalent) can be attached via this line set:

- IBM 2711 Line Adapter Unit
- Western Electric 103A1 and 103A2
- Western Electric 103F2
- Western Electric 202D1 and 202D2
- Western Union 1183A

### Data Line Set Expander

This feature provides for eight additional half-duplex line terminations as an expansion of the Data Line Set feature. Each expander is associated with the basic Data Line Set feature on a one-to-one basis, up to a maximum of 10 per 2703.

### IBM Line Set 1A

This feature provides the line terminations for a attachment to eight half-duplex privately owned lines via IBM Limited-Distance Line Adapter Type IA (two-wire IBM modem for distances up to 4.75 miles). It accommodates IBM 2740/2741 Communication Terminals. Maximum total of this feature and IBM Line Set 1B features cannot exceed twelve. This feature cannot be installed if any IBM Line Set 2 is installed.

### IBM Line Set 1B

This feature provides the line terminations for attachment to eight half-duplex privately owned lines via IBM Limited-Distance Line Adapter Type IB (four-wire IBM modem for distances up to 4.75 miles). It accommodates IBM 2740/2741 Communication Terminals. Maximum total of this feature and IBM Line Set 1A features cannot exceed twelve. This feature cannot be installed if any IBM Line Set 2 is installed.

### IBM Line Set 2

This feature provides the line terminations for attachment to eight IBM Limited-Distance Line Adapter Type II (two-wire IBM modem for distances up to 8 miles). It accommodates IBM 1030, 1050, 1060, 1070, and 2740/2741 systems and terminals. Maximum number of features per 2703 is four. This feature cannot be installed if any IBM Line Set 1A or 1B features are installed.

### Telegraph Line Set

This feature provides the line terminations for eight half-duplex telegraph lines. A maximum of twelve of these features are permitted on any one 2703.

### Telegraph Line Set Expander

This feature provides for eight additional half-duplex line terminations as an expansion of the Telegraph Line Set feature. Each expander feature is associated with the basic Telegraph Line Set feature on a one to one basis, up to a maximum of ten per 2703.

## Line-Speed Options

These speed options provide seven specific operating speeds from 45.5 bps to 600 bps to accommodate the wide range of start/stop type terminals attachable to the IBM 2703. Any one line-speed option of a given

Line Base Positions			Maximum * Number of Lines
A	B	C	
S/S I S/S I S/S I S/S I S/S I	S/S I S/S I S/S I S/S I S/S I	S/S I _____ S/S II Sync I A Sync I B	176
S/S I S/S I S/S I	S/S II Sync I A S/S II	S/S II Sync I A Sync I A	136
S/S I S/S I	S/S II Sync I B	Sync I B Sync I A	128
S/S I	Sync I B	Sync I B	120
S/S I S/S I	S/S II _____ _____ _____ _____	_____ Sync I A	112
S/S I	_____ _____ _____ _____	Sync I B	104
S/S I	_____ _____ _____ _____	_____ _____ _____ _____	88
S/S II S/S II S/S II	S/S II S/S II Sync I A	S/S II Sync I A Sync I A	72
S/S II S/S II	S/S II Sync I B	Sync I B Sync I A	64
S/S II	Sync I B	Sync I B	56
S/S II _____ S/S II	S/S II S/S I A _____ _____ _____	_____ Sync I A Sync I A	48
S/S II _____ _____ _____	_____ Sync I B	Sync I B Sync I A	40
_____ _____ _____ _____	Sync I B	Sync I B	32
_____ S/S II _____ _____ _____	_____ _____ _____ _____	_____ Sync I A	24
_____ _____ _____ _____	_____ _____ _____ _____	Sync I B	16

LEGEND

S/S I - Start-Stop Base Type I (88 Max line)

S/S II - Start-Stop Base Type II (24 Max lines)

Sync I A - Synchronous Base Type IA (24 Max lines)

Sync I B - Synchronous Base Type IB (16 Max lines)

Notes:

1. The maximum total Start-Stop type bases is three, while for the synchronous bases it is two. However, the combined maximum total is three.
2. The line base types shown in this chart are assigned by the base position (A, B or C) to conform with ordering procedures as follows:

- A-First S/S base.
- B-Second S/S base, or Second Sync base.
- C-Third S/S base, or First Sync base.

\* This maximum may be decreased when a 2712 is attached to the 2703. This decrease occurs whenever any 2712 Expander feature is installed, and is as follows:

--- Model 1 Expander - each of these features decreases the maximum available lines by six (6).

--- Model 2 Expander - each of these features decreases the maximum available lines by (2).

Figure 8. Line Base Configurations

Table I. Line Sets Per Line Base and Per 2703.

FEATURE NAME	per S/S Base Type I	per S/S Base Type II	per Sync Base Type IA	per Sync Base Type IB	per 2703
Data Line Set (incl. expanders)	11 (5 exp.)	3 (1 exp.)	—	—	22 (10 exp.)
Telegraph Line Set (incl. exp)	11 (5 exp.)	3 (1 exp.)	—	—	22 (10 exp.)
IBM Line Set IA	9	3	—	—	12
IBM Line Set IB	9	3	—	—	12
IBM Line Set 2	4	3	—	—	4
2712 Model 1 Adapter (incl. exp.)	8 (4 exp.)	3 (or 2 and 1 exp.)	—	—	8 (4 exp.)
2712 Model 2 Adapter (incl. exp.)	8 (4 exp.)	3 (or 2 and 1 exp.)	—	—	8 (4 exp.)
Sync Line Set	—	—	6	4	12
Sync Line Set with Sync Clock	—	—	3	3	6

speed operates all lines of that speed within any one 2703. The speed options available are: 45.5 bps, 56.9 bps, 74.2 bps, 75 bps, 110 bps, 134.5 bps, and 600 bps.

2712 Model 1 and Model 2 Adapter Features

The 2712 Adapter features, when used in conjunction with an IBM 2712 Remote Multiplexer, provide for concentration of a number of low-speed lines over one voice-grade (high-speed) line. Figure 9 shows a typical configuration. Half-duplex low-speed lines are brought into the 2712 Remote Multiplexer, which bit-multiplexes data from the terminals onto a full-duplex voice-grade line. The data is separated at the 2703 and fed into the individual 2712 Adapters in the 2703.

Data going to the terminals is multiplexed at the 2703 by the 2712 Adapter and sent over the other half of the full-duplex voice-grade line. The remote 2712 separates the data and sends it to the terminals over the lower speed lines. To the CPU, it appears to be working with a number of low-speed lines. Thus, no programming changes are required.

Two models of this feature are available. Model 1 operates with up to 10 lines (using a Model 1 Expander feature to provide for lines 9 and 10) at

speeds of 134.5 bps. This model permits attachment of such terminals as the 1050, 1060, 2740, and 2741. Model 2 operates at 74.2 bps with 83B2 or 83B3 line control (Model 28 teletypewriter terminal) and can have up to 14 lines (using a Model 2 Expander feature to provide for lines 9 to 14). A block of eight addresses must be assigned for each expander, as well as for each adapter feature. However, the Model 1 Expander utilizes only two of the eight assigned addresses, while the Model 2 Expander utilizes six of the eight assigned addresses.

Figure 10 shows the various configurations using the 2712 Model 1 and Model 2 Adapter features (with the Expander features) on the 2703 with maximum lines for each configuration. There can be a maximum of four expanded 2712 Adapter features (any combination) on one 2703.

NOTE: The 2712 Attachment feature is required for installation of either the 2712 Model 1 or Model 2 Adapter.

Model 1 requires a Type 3004\* (formerly Schedule 4 Type 4B) full-duplex private-line data channel, while the Model 2 requires a Type 3003\* (formerly Schedule 4, Type 4A) full-duplex private-line data channel. The 2703 is connected to the communications channel via Western Electric Data Set 202D2 or equivalent.

\*or equivalent

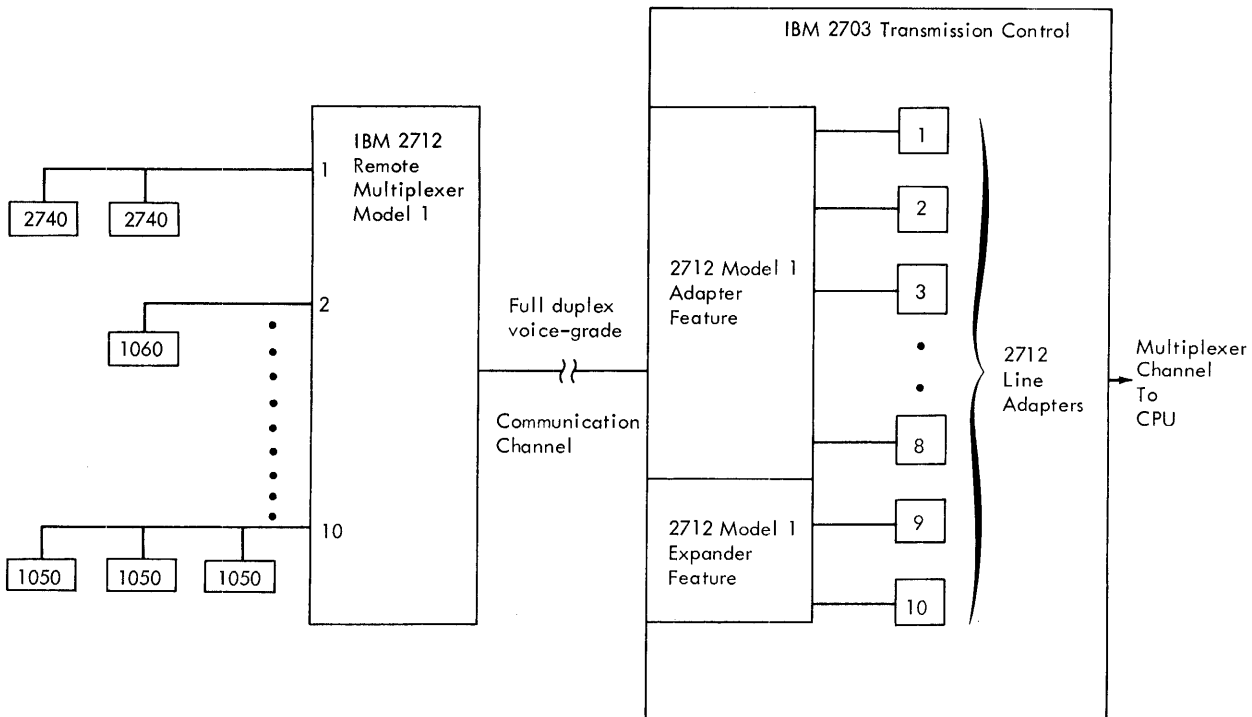

Figure 9. Typical 2712 Configuration

#### TERMINAL CONTROL OPERATIONS

The 2703 operates with the following terminal controls:

- IBM Terminal Control Type I
- IBM Terminal Control Type II
- Telegraph Terminal Control Type I
- Telegraph Terminal Control Type II

At least one such feature is required; a maximum of four start/stop terminal-control features is possible for any one 2703.

#### IBM Terminal Control Type I

This feature provides controls necessary for the attachment of 2740, 2741, 1050, 1060, and 1070 terminals at 14.8 cps (134.5 bps); 1070 terminals at 66.6 cps (600 bps); or 1050 terminals (with the Telegraph Attachment feature) at 75.0 bps. The transmission code is six bits plus parity, with the following relation to the System/360 channel interface:

0	1	2	3	4	5	6	7	System/360 Byte
Shift						Check		
S	B	A	8	4	2	1	C	Six-Bit BCD

In the six-bit BCD transmission code,  $\text{\textcircled{S}}$  represents the shift bit. A logical one identifies the upper case; a logical zero represents the lower case. The  $\text{\textcircled{B}}$  bit is the first bit transmitted after the start bit. An odd-parity (check) bit is transmitted following the 1 bit. Each received character is checked for odd vertical parity.

Shifted-character-set conversion, a standard feature, automatically deletes the upshift and downshift characters from the received data stream, notes the last shift character received, and inserts an eighth bit,  $\text{\textcircled{S}}$ , to indicate the appropriate shift character to the System/360. On outgoing data, the  $\text{\textcircled{S}}$  (shift) bit is removed and noted. A change in this  $\text{\textcircled{S}}$  bit automatically causes insertion of the appropriate shift character (upshift or downshift) into the outgoing data stream before sending the data character.

Model 1 and Expander Feature

2712 Adapter Models with Expander feature	0	1	expander	2	expander	3	expander	4	expander
0	0	8	10	18	20	28	30	38	40
1	8	16	18	26	28	36	38		
expander	14	22	24	32	34	42	44		
2	22	30	32	40	42				
expander	28	36	38	46	48				
3	36	44	46						
expander	42	50	52						
4	50								
expander	56								

Model 2 and Expander Feature

- Note:
1. The total low speed line terminations available for any given 2712 configuration is determined by the intersection of the Model 1 and Model 2 coordinates. All indicated features are accumulative, thus the second model 1 adapter feature assumes prior attachment of the first model 1 feature with the first expander feature, etc.
  2. The Expander features require a block of eight addresses, while providing two line terminations for the Model 1, or six line terminations for the Model 2.

Figure 10. Total Low-Speed Lines Available by 2712 Model Configurations



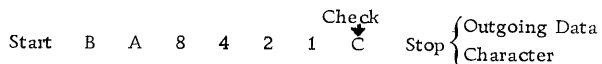

The  $\textcircled{C}$  (check) bit in the character indicates the correct odd-parity count: a logical one if the bit count of the character is even, a logical zero if the bit count of the character is odd.

Vertical redundancy check (VRC) and longitudinal redundancy check (LRC) are provided. Any error detected sets the Data Check bit within the sense byte. A Data Check does not cause immediate termination of the current command.

### Polling and Addressing

Polling and addressing of the 1050, 1060, 1070, or 2740 terminals are performed by a Write and a Read command or by a Poll command preceded by a Start I/O instruction. When polling, command chaining is utilized so that the Read command and the allocated storage are ready to receive the incoming data. In the first case (a Write and a Read command), on sending out polling characters (provided by the program), chaining occurs to a Read command, and a timeout begins. At this point, the IBM Terminal Control Type I pre-empts the 28-second timeout provided by the common controls and storage with its two-second short timeout. The 2703 interrupts the CPU program if a  $\textcircled{N}$  character is received or if a timeout occurs. Unit Exception is set in the unit status byte if  $\textcircled{N}$  is received. Unit Check is set in the unit status byte if a timeout occurs; the Timeout bit is set in the sense field. Using the Poll command, the 2703 will end the command with the Status Modifier if a positive response is received from the terminal. If no response, or an incorrect response, is received, the command is ended with Unit Check status and the appropriate sense indication. If all terminals have been polled and no positive response has been received, the command will end normally. The program is required to follow each address with an index character, which will be returned to the processor upon a positive response from the terminal. To initiate a receive operation from a 2740 or 2741, a Prepare command is followed by a Read command; then, data transmission is started.

During addressing, command chaining to a Read command is used to provide for receiving the  $\textcircled{N}$  or  $\textcircled{Y}$  character.  $\textcircled{N}$  sets Unit Exception in the status byte, as in polling, to interrupt the CPU program.  $\textcircled{Y}$  causes a normal end, which can be command chained to the output message.

### Character-Recognition Summary

The following characters are recognized during transmit operations:

1.  $\textcircled{C}$ , which sets control mode and resets the check-character (LRC) accumulator.
2.  $\textcircled{D}$ , which sets text-out mode and initiates LRC accumulation.  $\textcircled{D}$  is recognized if the line is in transmit direction and in control mode or text-in mode. This character has no control effect if transmitted while the line is in text-out mode. (It is treated as a normal data character.)
3.  $\textcircled{B}$ , which sets LRC sequence. Termination of the Write command is initiated by  $\textcircled{B}$ .
4. In text-out mode and in downshift (a 0 in the shift bit), any character with the S bit ON causes the line to send the upshift character and sets a 1 in the S bit before being transmitted.
5. In text-out mode and upshift (a 1 in the shift bit), any character with the S bit OFF causes the line to send the downshift character and sets a 0 in the S bit before being transmitted.
6. A pad character from the channel causes all Marks to be transmitted for one complete character time.

The following characters are recognized during read operations:

1.  $\textcircled{C}$ , as end of transmission, which sets control mode and End and Unit Exception status in the address lines.
2.  $\textcircled{D}$ , which is recognized when the subject line is in control mode or poll mode and causes text-in mode to be set and LRC accumulation to be initiated. When in the receive direction, and when not in control mode,  $\textcircled{D}$  is treated as a normal data character.
3.  $\textcircled{B}$ , which sets the LRC control sequence. The next received character will be checked against the accumulated LRC before the Read command is terminated.
4.  $\textcircled{N}$ , which sets End and Unit Exception when in control mode. End and Data Check are set when  $\textcircled{N}$  is received and the operation is in text-out mode.
5.  $\textcircled{Y}$ , which sets End during control mode and text-out mode.
6. Upshift, which sets upshift (1 in the S bit) if the line was in downshift (0 in the S bit); if the line was already in upshift or in control mode, this character has no effect. In any case, the terminal control inhibits transfer of this character to the data word, removing it from the incoming data stream, although it is included in the accumulated LRC character if the line is in text mode while receiving.

7. Delete (BA8421C) is removed from any incoming data stream because its transfer is inhibited by the terminal control. However, this character is included in the accumulated LRC character if the line is in text mode.
8. Idle (B8421) is removed from any incoming data stream because its transfer is inhibited by the terminal control. However, this character is included in the accumulated LRC character if the line is in text mode.

### IBM Terminal Control Type II

This feature provides the controls necessary for the attachment of 1031 input stations and the 1033 output printer at 600 baud. The transmission code is six bits plus parity, with the following relation to the System/360 channel interface:

0	1	2	3	4	5	6	7	System/360	Byte
-	B	A	8	4	2	1	C	1030 Code	

B is the first bit transmitted onto the line following the start bit.

A minimum of two stop bits will be transmitted for every character; however, due to the unique mode of operation of the 1031 input station, only one stop bit is anticipated in receive mode (after which the 2703 begins looking for the next start bit).

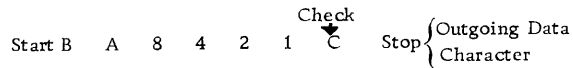

Each received and transmitted character is checked for odd vertical parity. VRC errors will cause Data Check to be set in the control-word sense field bit will not cause termination of the current command. Unit Check will be set in the status field.

### Polling and Addressing

Polling of 1031 input stations is performed by Write and Read commands or Poll and Read commands issued under Start I/O. When polling, command chaining should be utilized, so that the Read command and allocated storage is ready for incoming data as quickly as possible. After the polling characters (provided by the program) are sent out, chaining occurs to a Read command, and a three-second timeout begins. The IBM Terminal Control Type II pre-empts the 28-second timeout provided by the common controls with the three-second short timeout because the line is in control mode. Interruption of the program will occur if  $\text{N}$  is received or if timeout occurs. Unit Exception will be set in the unit status byte if  $\text{N}$  is received. Unit Check will

be set in the unit status byte if a timeout occurs, and the Timeout bit will be set in the sense field. When using the Poll command, the program is required to follow each address with an index character, which will be returned to the processor upon a positive response from the terminal.

Addressing of 1030 output devices (1033) is performed by a Write command issued under Start I/O. The address characters  $\text{C}$ ,  $\text{S}$ , and terminal address are provided by the program. Command chaining to a Read command is utilized to provide for receiving the  $\text{N}$  or  $\text{Y}$  character.

$\text{N}$  will set Unit Exception status to interrupt the processor program.  $\text{Y}$  will cause the normal end, which allows command chaining to a Write for the output message. If no response is received, Unit Check is set in status, Timeout is set in sense, and the command is ended.

### Character-Recognition Summary

The following characters are recognized during transmit operations:

1.  $\text{C}$ , which sets control mode in the control word of the line.
2.  $\text{D}$ , which sets text-out mode in the control word when in control mode.
3. Pad character.

The following characters are recognized during receive operations:

1.  $\text{B}$ , which sets End in the control word.
2.  $\text{D}$ , which sets text-in mode.  $\text{D}$  is recognized only if the line is in control mode or poll mode; otherwise, it has no control effect and is treated as a normal data character.
3.  $\text{N}$ , which sets End and Unit Exception when in control mode. End and Data Check are set when  $\text{N}$  is received in text-out mode.
4.  $\text{Y}$ , which sets End in the control word of the associated line.
5. Delete (BA8421C) is removed from any incoming data stream because its transfer to the control word is inhibited by the terminal control.
6. Idle (B8421) is removed from any incoming data stream because its transfer to the control word is inhibited by the terminal control.

### Telegraph Terminal Control Type I

This terminal control provides the necessary controls for operating telegraph terminals under AT&T 83B2, AT&T 83B3, or WU Plan 115A line control. The transmission speed is either 45.5, 56.9, or 74.2 bps. One of these speeds must be chosen. Transmission code is Baudot, with the following relationship to the System/360 channel interface:

0	1	2	3	4	5	6	7	System/360	Byte
-	-	S	1	2	3	4	5	Baudot	

"S" represents the case. A logical one identifies upper-case; logical zero, lower-case. The 1 bit is the first bit transmitted after the start bit.

Shifted-character-set conversion is provided as standard. The shift characters are LTRS for "letters" (or "downshift") and FIGS for "figures" (or "upshift"). In addition, "unshift on space" is provided as a standard-wiring optional feature of this terminal control; "unshift on space" means that the space character causes the line to go to LTRS mode if transmitted or received. The terminal control must be wired for "unshift on space" only if the attached 83B2 or 83B3 and 115A teletypewriter terminals have this feature installed; a combination of Type I telegraph lines with and without this feature is not permitted in a single 2703.

LTRS and FIGS characters are automatically deleted from the received data stream, and the case is remembered in the lines-control word. Space characters are not deleted from the received data stream (whether with or without the "unshift on space" feature wired in), but the LTRS case is then remembered. A sixth bit, set by the terminal control, is added to the code to indicate case to the processor. Data bytes transferred from the channel will be in six-bit form. The terminal control will remove the sixth bit and remember the case. A change in case will automatically cause insertion of the proper shift character (LTRS or FIGS) into the outgoing stream. The terminal control will send 1.5 stop bits and check for the presence of one stop bit on receive. After the 2703 is reset, the line will be in lower case.

#### Polling and Addressing

Polling and addressing of 83B2, 83B3, or 115A terminals are performed by Write or Read commands issued under Start I/O. When polling, command chaining should be utilized so that the Read command and allocated storage is ready for incoming data as quickly as possible. After the polling characters (provided by the program) are sent out, chaining occurs to a Read command, and a two-second timeout begins. The Telegraph Terminal Control Type I pre-empts the 28-second timeout provided by the common controls with its two-second short timeout while the line is in sequence zero. Interruption of the program will occur if a timeout completes. Unit Exception will be set in the unit status byte if the EOT sequence is received. For this terminal

control, the EOT sequence is FIGS-H, LTRS (where FIGS-H is the H character received while the line is in upper case; that is, the last shift character received before the H was "figures-shift"). FIGS-H must be followed immediately by the letters-shift character (LTRS) to complete the EOT sequence. Unit Check is set in the unit status byte, and the Timeout bit will be set in the sense field if a timeout occurs. However, note that when the program sends EOT, it should send the three-character sequence--FIGS-H, LTRS--because some teletypewriter terminals will recognize only this sequence as EOT.

When addressing, command chaining to a Read command is utilized to provide for receiving the "V" (or "M") response.

A timeout will set Unit Check in the unit status byte and Timeout in the sense field as when polling, to interrupt the processor program. A "V" (or "M") answerback will cause a normal end, which may be used to command chain to the output message.

#### Terminal-to-Terminal Operation with Search

For terminal-to-terminal operation between two terminals on the same line, the operation should proceed as follows:

1. The sending terminal must be polled to activate its tape reader (assuming it has a message to send). This should be done in the conventional manner with a Write command. If the message is to be sent to stations on other lines or if it is to be logged or processed by the CPU, the first address on the tape should be "AZ", the CPU's own address. Otherwise, the address on the tape should be that of the station on the same line to which the terminal-to-terminal message is to be sent.
2. The Write command that sends the polling characters should be command chained to the Search command. The Search command should have a byte count of two and the SLI (suppress length indication) bit should be OFF in its CCW. If the polled station has no message to send, it will respond with "V", and the command will be terminated with Channel End and Device End status. Because only one byte is transferred to the channel (the "V" or "M" reply), the channel causes a record-length interrupt to the program. The program should then proceed to poll the next station.
3. If the station had a message and the first address is "AZ", the "AZ" is transferred to the processor under the Search, and the command is then ended with Channel End and Device End status. Because two bytes were

transferred, no record-length interrupt occurs and the channel can command chain to a Write to send the "V" answerback to the polled station. This permits the station to start its tape reader and continue to send the message.

4. If another reply to the poll is received under the Search, the 2703 will scan the data on the line until it recognizes the EOT sequence (FIGS-H, LTRS), at which point it transfers the "H" to the processor and ends the command with Channel End, Device End, and Unit Exception status. No transfer of data occurs during this scan.
5. The Write command should then be command chained to a Read to receive the message.
6. Line timeouts are active during execution of the Search command. If the first address on the tape begins with "A" but is not "AZ", the "A" will be transferred to the processor, but otherwise the operation is normal; the "H" of the EOT sequence will be placed in the next position in core storage.

#### Character-Recognition Summary

The following characters are recognized during write-type operations:

1. In LTRS mode, any character with the S bit ON causes the line to send the FIGS character and set the shift bit before it is transmitted.
2. In FIGS mode, any character with the S bit OFF causes the line to send the LTRS character and reset the shift bit before it is transmitted.
3. If wired for "unshift on space" operation, the space character sets LTRS mode. In this case, the S bit accompanying the space character is ignored.

The following characters are recognized during read-type operations:

1. A "V" (or "M") received as the first character will set End status.
2. FIGS-H, LTRS received as EOT (end of transmission) sets End and Unit Exception status.
3. The two-character processor address "AZ", if received as the first two non-letters characters of a message under the Search command, will set End.
4. LTRS (letters shift), which sets downshift (0 in the S bit) if the line was in upshift (1 in the S bit). In any case, this terminal control inhibits transfer of this character to the I/O channel, removing it from the incoming data stream.
5. FIGS (figures shift), which sets FIGS mode if the line was in LTRS mode, and has no effect

if the line was already in FIGS mode. In any case, this terminal control inhibits transfer of this character to the I/O channel, removing it from the incoming data stream.

6. If wired for "unshift on space" operation, the space character sets downshift (0 in the S bit) when it is received. The space character is then transferred to the I/O channel with its S bit zero.

#### Telegraph Terminal Control Type II

This feature provides the controls necessary for the attachment of Teletype Corporation's Models 33 and 35 Teletypewriter terminals to the 2703. Operation is point-to-point and, generally, on a dial-up basis. The transmission speed is 110 bps, with an eight-bit data code. The code employed is the eight-bit data-interchange code with the following relationship to the System/360 interface:

0	1	2	3	4	5	6	7	System/360 Byte
1	2	3	4	5	6	7	8	35 Teletype Code

One start bit and two stop bits are transmitted and received by this terminal control.

Identification answerback from the 2703 is handled by the processor. Output messages may be of any length or format. Input messages may be of any length. However, certain format restrictions are imposed due to the line control adopted by these terminals. On input, or during read-type operations, the following characters are recognized by the 2703; they cause termination of the I/O operation, with subsequent interruption of the Communications IOCS:

1. WRU--"Who are you"--which causes End status in the LCW.
2. XOn--"Transmitter on"--which causes End status in the LCW.
3. XOff--"Transmitter off"--which causes End status in the LCW.
4. EOT--"end of transmission"--which causes End and Unit Exception status in the LCW.
5. The delete character (all Marks) is recognized by the terminal control. Transfer of deletes to the I/O channel is inhibited during all read-type operations.

The Break signal may be detected during transmission. If the receive-data lead at the data set is at Space for two successive transmit-start times, the write operation is terminated with Channel End, Device End, and Unit Check status, and Data Check is set in the sense field.

## 2741 Break Feature

The 2741 Break feature (in conjunction with IBM Terminal Control Type I) provides the necessary control to operate the IBM 2741 Communications Terminal having an Interrupt feature. The 2741 Break feature modifies the terminal-control operation in two ways: (1) Normally, the IBM Terminal Control Type I sets Channel End, Device End, and Unit Exception status upon receiving a © character during a Read, Inhibit, or Prepare command. With the 2741 Break feature, only Channel End and Device End will be set in this situation, thus allowing command chaining to occur; (2) The IBM Terminal Control Type I does not look at the receive-data lead from the Western Electric Data Set 103A1, 103A2, or 103F2 while transmitting. When the 2741 Break feature is present, the receive-data lead is monitored for Space during a transmit operation. If a Space signal is detected for a character time, the

Write command is ended with Channel End, Device End, and Unit Check in the status byte and Intervention Required in the sense byte.

The Break feature in the 2741 is implemented by the Attention key on the 2741; when pressed, this key initiates a Space of 200 ms on the terminal-to-multiplexer channel. For the appropriate IBM Line Adapters or data sets available for use with this Break feature, refer to the Interrupt special feature in the component-description manual, IBM 2741 Communications Terminal, Form A24-3415.

After getting the Intervention Required during a Write command, the program may give a Prepare command followed by a Halt I/O command. The 2703 will present Channel End and Device End status as soon as the line goes back to Mark. This distinguishes the line break from the nonoperational subset that will end the Prepare command immediately with Channel End, Device End, and Unit Check in the status byte and Intervention Required in the sense byte.



## INTRODUCTION TO BSC

The Binary Synchronous Communications (BSC) features provide the 2703 with the ability to operate with other BSC-adapted stations and terminals, thus providing the following System/360-based communications capabilities:

- Attachment of up to 48 medium-speed lines at speeds up to 2400 bps, coupled with powerful error-detection capabilities.
- Versatility of transmission code used: EBCDIC, USASCII, SBT.
  - EBCDIC--Extended Binary-Coded-Decimal Interchange Code.
  - USASCII--United States of America Standard Code for Information Interchange (formerly called ASCII, American Standard Code for Information Interchange).
  - SBT--Six-Bit Transcode.
- Transmission of a full range of bit patterns when operating in transparent mode.
- Increased throughput by ability to transmit two packed-decimal digits in a given character-time frame, as well as ability to transmit unedited information.
- Multipoint operation, on leased communications networks with station-selection features.
- Programmed dialing of remote stations (via Autocall feature) and automatic answering of "calls" originated by a remote station.
- Operation on point-to-point leased communications networks using a contention system.
- Reduced (or eliminated) code-translation operations in CPU before and/or after transmission.
- Incorporation of flexible line-control procedures adaptable to the user's requirements.
- Auto-polling capabilities as standard.
- Attachment of the 2703, with the Synchronous Base I and Synchronous Features, to the multiplexer channel of the System/360 Models 30, 40, or 50; or to the System/360 Models 65 and 75 via the IBM 2870 Multiplexer Channel.
- Provision by the Synchronous Features of communications attachments with another Synchronous-Feature-equipped IBM 2703, to an SDA-II equipped IBM 2701 Data Adapter Unit, or to an IBM 2780 Data Transmission Terminal.

## GENERAL DESCRIPTION OF BSC OPERATIONS

The IBM 2703 Binary Synchronous Communications operations use circuitry provided by the basic 2703 as well as by the Synchronous Base I and Synchronous Features. For reading ease, therefore, references in this publication will be to Synchronous Features (SF) rather than to specific circuit areas.

The BSC uses a data-link control procedure and its associated control-character repertoire. (Understanding the difference between a "code" and a "data-link control" procedure is important. A code--such as EBCDIC, USASCII, SBT--consists of bit configurations having meaning to a circuit, or a program. As such, it can be compared to a word in the English language. On the other hand, a "data-link control" procedure is one that determines the sequencing of the coded characters. This sequencing can be compared to the English grammar that determines the sequencing of words in the language.) This data-link procedure (and associated repertoire) provides a "common communications-control language," and is applicable to EBCDIC, USASCII, and SBT. It implements the control of the following aspects of data transmission:

- Establishment of communications through--
  - Contention (point-to-point system control);
  - Multipoint control operations (selection and polling);
  - Switched-network operations (automatic answering and automatic disconnect).
- Message transmission--
  - Message-exchange operation (heading and text transmission);
  - Data blocking;
  - Transmission-error checking;
  - Station-status replies;
  - Enquiry functions and alternating replies;
  - Transparent-data transmission.

The basic control of the transmission link between two BSC-adapted items of equipment is accomplished by the recognition of the data-link-control character in conjunction with established equipment-generated timeouts. All transmission over the data link is a binary-bit stream and is synchronous by bit and by character. Bit synchronism is established by the modem (data set), or by an optional internal clock

when the modem (data set) does not provide the synchronizing signals. Character phase (character synchronism) is established, after bit synchronism, by the recognition of a "sync pattern" (two consecutive SYN characters). Once character phase is established between two stations involved in a given transmission, it is maintained until the transmission is terminated. Synchronism is aborted if no sync patterns or terminating or turnaround control characters are detected within a pre-established timeout period.

### Transmit Operations Using Data-Link Characters

During binary-synchronous communications, transmit operations are those occurring when data is transferred from main storage to a remote station via the SF and communications facilities. The SF is said to be in transmit mode when transmitting information in this direction.

See the publication, General Information-- Binary Synchronous Communications, Form A24-3004, for a conceptual discussion of the total binary-synchronous operations, including line-control repertoire, description of control procedures, control-character sequencing, and transmission-code structures.

The following discussion of control characters relates to the various applicable control characters as implemented by the SF.

#### SYN Character

SYN characters are generated at the beginning of the Write command and are inserted into the data stream as time-fill whenever a character is not available in time during a write transmission. The SYN character is generated into the data stream in order to maintain character synchronization. SYN characters are not included in the block-check-character (bcc) accumulation (see "Transmission-Code Checking" later in this section of this manual).

The programmer can insert a SYN character whenever there is need for time-fill in the program; however, the SYN characters will be deleted by the receiving equipment involved in the data transmission.

The SF does not transfer the time-fill (SYN) to receiving storage.

For synchronization purposes, two SYN characters per second are inserted into the data stream while the SF is in text mode, or DLE SYN is inserted while in transparent mode.

#### SOH and STX Characters

The SF monitors for the presence of these two control characters. Upon detection of either SOH or STX, the SF enters into text mode and initiates block-check-character accumulation. After the SF has entered into text mode, any subsequent SOH or STX characters detected are treated as non-control characters.

In any particular data block, the SOH or STX that initiated bcc accumulation is not included in the bcc accumulation; however, any ensuing STX or SOH characters in the data block are included in the bcc accumulation.

During transmission, exit from text mode is accomplished by the SF detecting either an ETX or ETB control character or an Interface Stop, or by the Halt I/O instruction.

Since the SF requests multiple bytes from main storage, bytes following the ETX and ETB may be transferred into the 2703 prior to the ending of the command. These additional bytes are not transferred to the line.

#### ETB and ETX Characters

These control characters cause the SF to exit from text mode and also cause the accumulated block-check character to be transmitted. After the transmission of the bcc, the SF goes into receive mode (i. e., SF stops transmitting) and hunts for a sync pattern.

#### EOT, ACK, and NAK Characters

These three control characters are ignored as control characters when the SF is operating in transmit mode.

#### ITB Character

This control character causes the block-check character to be sent following the transmission of the ITB character. The SF continues to transmit. Two SYN characters are generated by the SF and transmitted immediately after the bcc character. If the "intermediate block mode" bit (see Set Mode command) is set to zero, the ITB character is ignored. The SF begins accumulation of a new bcc after the ITB bcc sequence has been transmitted. The direction of transmission is not reversed following the ITB, as it is following the ETX.



## DLE Character

The DLE control character, plus a defined follower character, initiates a control sequence. Thus, for example, the DLE STX sequence places the SF in transparent mode. While in transparent mode, the SF inserts a DLE character into the data stream whenever a DLE is received from main storage.

Time-fills consist of DLE SYN sequences. The DLE SYN sequence is generated by the equipment; thus the programmer cannot use DLE SYN for time-fill while in transparent mode.

The first DLE, after a DLE STX in any sequence, is not included in the bcc accumulation, nor is a DLE SYN sequence included.

Any transmitted DLE followed by an end control character must be contained in a second Write, CCW which is command chained to the first Write, CCW.

## ENQ Character

The ENQ control character is not recognized as a control character if detected under a Write command. If ENQ is detected under a Poll command, it turns the SF from transmit mode to receive mode.

The ENQ does not signal End to the program under a Poll command.

## Receive Operations Using Data-Link Characters

For binary-synchronous communications, receive operations are those occurring when data is received from a remote station. The SF is considered in receive mode whenever it is not in transmit mode.

## SYN Character

All SYN characters are deleted from the received data stream by the SF before the received data is transferred to main storage. Any SYN characters detected by the SF in the received data stream are not included in the block-check-character accumulation.

## SOH and STX Characters

These two control characters initiate all bcc accumulations. Their initial detection sets the SF in text mode. The initial SOH or STX control characters are not included in the bcc accumulation. Subsequent SOH and STX characters in a data block are treated as noncontrol characters (i. e., data characters), and are included in the bcc accumu-

lation. Exit from text mode is accomplished when the SF signals End to the program.

## ETB and ETX Characters

These control characters signify that the check character is following. The SF remains in receive mode.

On a Read command, the ETX or ETB always signals End to the channel. When the SF is in intermediate-block mode (see Set Mode command), an ETX or ETB causes an Error Index byte (EIB) to be inserted immediately after ETX or ETB in the data being transferred to main storage.

## ENQ, ACK, and NAK Characters

These control characters signal End to the channel and do not change the SF from receive mode. No bcc comparison is performed after detection of these characters. The SF hunts for a new sync pattern.

## DLE Character

This control character, followed by a defined follower character, initiates a control sequence when the SF is operating in transparent mode.

To initiate transparent mode, the SF monitors the incoming data for the DLE STX sequence. While in transparent mode, a DLE DLE sequence is interpreted as a normal data character with the first DLE being deleted and the second DLE is sent to main storage. The DLE SYN sequence is detected as time-fill with the DLE and SYN deleted from the data stream going to main storage. Neither the DLE nor SYN is included in the bcc accumulation.

A single DLE character followed by a DLE, SYN, or end character sets the Data Check bit in the sense byte. The Read command is ended with Channel End, Device End, and Unit Check status signaled to the channel status word (CSW) when either the proper DLE-end character sequence is recognized or a timeout occurs.

A DLE followed by any end control character causes the SF to leave transparent mode, with the end character handled the same as in normal transmission. The DLE character preceding the end character and the first DLE in a DLE DLE sequence are not included in the bcc accumulation. All DLE sequences must be contiguous characters on the transmission line.

NOTE: For DLE sequences as pertaining to ACK 0, ACK 1, and WABT (for the several transmission codes), see the publication, General Information--Binary Synchronous Communications, Form A27-3004.

## EOT Character

This character will cause the SF to remain in receive mode. No bcc comparison is performed on the received data. Channel End, Device End, and Unit Exception status is signaled to the CSW.

## ITB Character

When the SF is in intermediate-block mode, this character indicates that the following characters are the block-check characters. The SF remains in text mode and the accumulation of a new bcc is restarted with the next character (except SYN) following the last bcc. The bcc accumulation is reset immediately after the intermediate-block-check operation has been performed. The ITB character is acted upon only if bit-position 1 of the set-mode byte is set to one.

Each time an ITB is detected, the SF checks the bcc accumulation and passes on to main storage an Error Index byte following the ITB (or ETB or ETX) character. The Error Index byte (EIB) reflects the condition of the last block of data received (a non-zero content indicates a transmission error).

The EIB informs the program of data-check or overrun conditions detected while the block of data was being received. These conditions set the following bits in the EIB:

<u>Bit Position</u>	<u>Condition</u>
4	Data Check
5	Overrun

The EIB character is stored in the byte location immediately following the ITB (or ETB or ETX) character of the data block involved in the read operation.

The ITB character is used to break up a long record into shorter blocks; each block (except the last) is ended with an ITB character. The direction of transmission is not reversed following the ITB, as it is following the ETX.

The record will end normally upon detection of an ETB or ETX character.

## SYNCHRONOUS OPERATIONS

The Synchronous Base (SB) provides the circuitry for two-way, nonsimultaneous (half-duplex), serial, synchronous data communication over leased or switched transmission facilities having voice-grade qualities. Information transmission (consisting of data bytes, logical information, line-control characters, error-checking characters, etc.)

consists of binary streams, serial by bit and by character, between two BSC-adapted stations. The stations operating over the data link may be BSC-adapted computers, terminal, remote I/O devices, control units, or other equipment. For example, two System/360 computers can typically operate over a communications path as shown in Figure 11.

The Synchronous Attachment is a prerequisite to attaching any BSC capability to the 2703. Two Synchronous Bases can be installed in a 2703. The attachment of the Synchronous Attachment feature in a 2703 requires the installation of the Base Expansion feature.

Operationally, the SF is fully controlled by the channel program in conjunction with the data-link-control signals it receives from the remote station via the communications network and the signals it receives via the multiplexer channel attached to the main-storage CPU.

The SF performs the following functions:

- Provides the required buffering between the 2703 and the attached BSC-adapted remote station.
- Checks the accuracy of received data between the 2703 and the remote station.
- Scans the received data-link-control characters and control-character sequences and initiates certain actions.
- Initiates data transfer to main storage on read-type commands and to the remote station on write-type commands.
- Automatically generates time-fill and check characters as required.
- Generates several timeouts--of fixed duration--to prevent system "hang-up" and unwanted looping.

The SF informs the processor if its status (thus reflecting the status of attached stations) via the status and sense bytes. The program interrogates each received response to determine if any further action is required. For example, if:

- the remote station signals EOT (end of transmission).
- an attempt to transmit or receive a data block fails.
- erroneous or invalid characters are transferred in either direction between main storage and the 2703; or erroneous or invalid characters are received from the remote station.
- an error in sequencing of certain commands occurs, or if invalid commands are attempted to be executed.
- timeout conditions occur.

## BSC Special Features

The BSC permits wide selectivity in the features employed, thus permitting equipment options designed to the user's communications network and his operating modes.

Synchronous Terminal Controls (STC) and Synchronous Base IA and IB provide for information transfer between core storage and the communications facility. The Synchronous Base performs character assembly on data being read into core storage and character disassembly on information passing in the opposite direction.

### Synchronous Terminal Controls

A Synchronous Terminal Control (STC) is required for attaching synchronous terminals (or stations) to the 2703. Synchronous Terminal Controls are optionally available for communicating in EBCDIC, USASCII, or SBT. Each of the three available STC's contains circuitry for transmission-error-detection operations. The method used in error detection varies depending on the transmission code used. The STC controls all lines (independent of the number of Synchronous Bases, number of lines, and line speed employed) of a specific code type. Up to three STC's can be installed in each 2703. Mixes of Synchronous Terminal Controls with start/stop terminal controls (e. g. , Telegraph Terminal Controls or IBM Terminal Controls) are permissible provided only two STC's are installed per 2703. No more than two types of Synchronous Terminal Controls may be associated with one Synchronous Base. (See Figure 3.)

The three transmission codes available are:

EBCDIC--Extended Binary-Coded-Decimal Interchange Code. This eight-bit code allows transmission of 256 different bit patterns. Ten (optionally eleven with ITB) of these bit patterns represent data-link characters assigned as line-control characters. In addition, the following characters are currently assigned in EBCDIC:

- 52 alphabetic characters (upper and lower case)
- 10 numeric characters
- 22 end-to-end characters
- 33 special graphics (including space)

EBCDIC is code-compatible with the internal code used in System/360, thus permitting maximized utilization of communications facilities and of channel-to-control-unit data paths to the 2703, CPU and main storage. Information is stored in main storage directly as received without need for translation. For the three transmission codes, bit-position 7 of the byte in main storage is always transmitted onto the communications line as the first bit.

The first bit received from the transmission facility always goes to bit-position 7 of the byte in main storage.

USASCII-United States of America Standard Code for Information Interchange.\* The USASCII code consists of seven data bits plus an odd-parity check bit in the eighth bit position. USASCII provides up to 128 bit patterns, all of which have assigned characters as follows:

- 10 data-link characters
- 52 alphabetic characters (upper and lower case)
- 10 numeric characters
- 23 end-to-end characters
- 33 special characters (including space and delete)

USASCII characters are received by the 2703 directly as received from the communications facility. Figure 12 gives examples of code translations of a received character to EBCDIC or ASCII-8.

SBT--Six-Bit Transcode. The SBT provides for the transmission of 64 bit patterns assigned the following character representations:

- 10 data-link characters [includes ITB (US--Unit Separator)]
- 26 alphabetic characters (upper case)
- 10 numeric characters
- 12 special characters (includes space)
- 6 end-to-end characters

SBT is essentially a card-oriented transmission code for information entry from remote card machines not requiring the extended code of EBCDIC.

### Transmission-Code Transparency

Each of the three transmission codes may be used in transparent-text mode. Transparency permits the unrestricted use of all bit patterns, within each transmission-code type, to be transmitted and received as strictly a binary-bit stream, using a special procedure for control-character recognition.

Within the several transmission codes, transparent-text mode is useful in transmitting messages as:

- Fixed-point data
- Floating-point data
- Packed-decimal digits
- Logical information

---

\*This code is compatible with the United States of America Standard Code for Information Interchange (USASCII). However, this does not imply full compatibility with non-IBM synchronous USASCII devices currently being marketed.

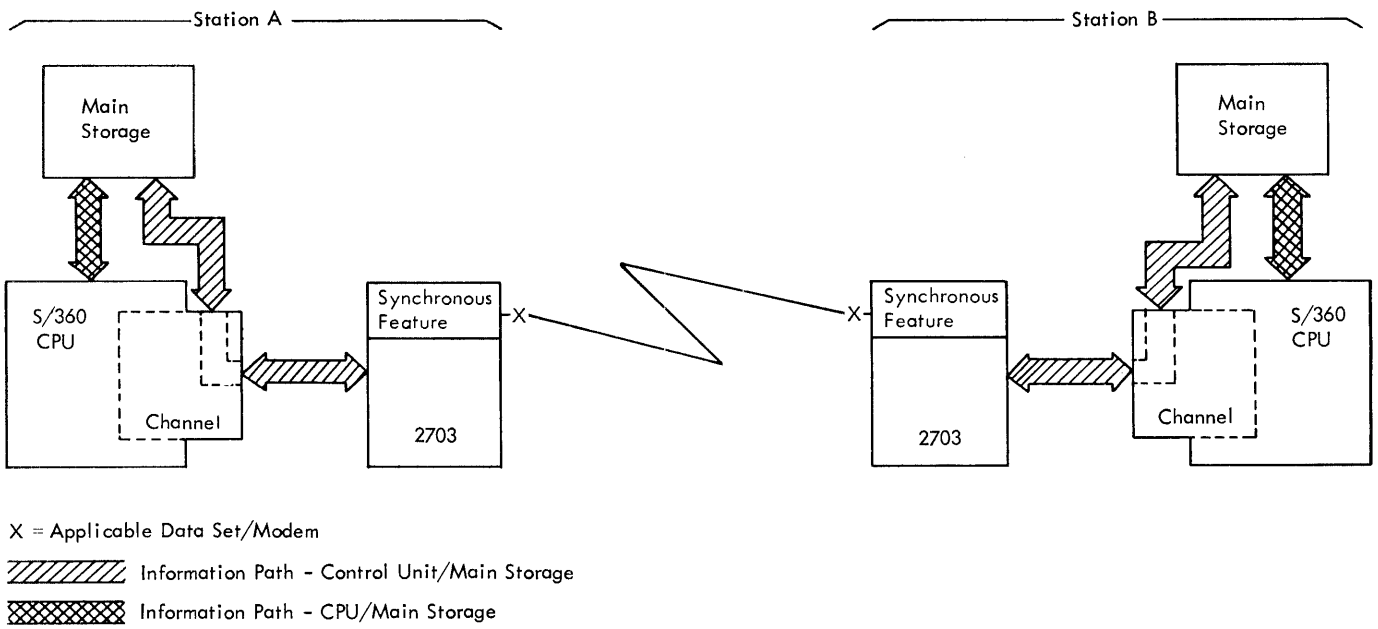

Figure 11. Operation of Two System/360 Computers over a Communications Line

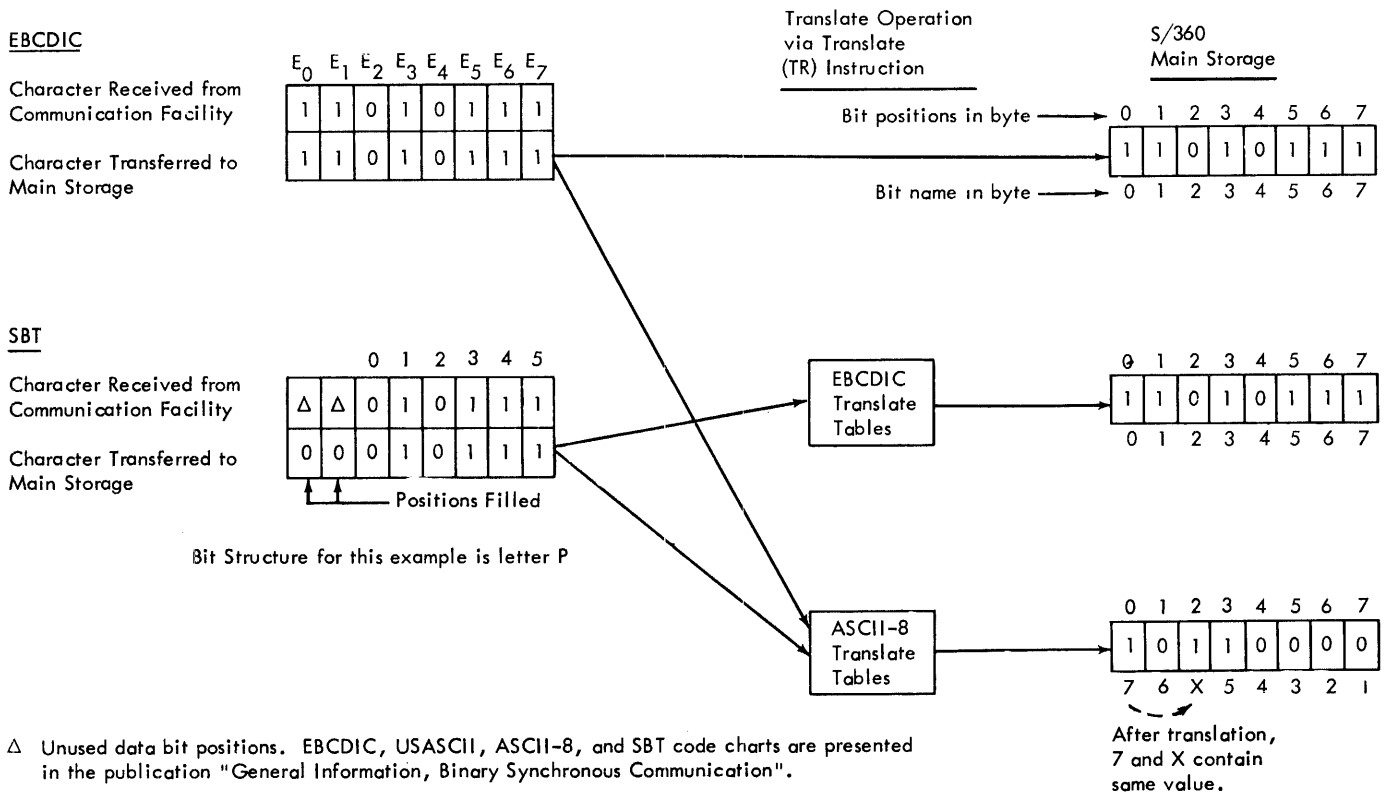

Figure 12. Code Translation of a Received Character (to EBCDIC or ASCII-8)

Code-conversion operations  
 Source-program information  
 Groups of short messages  
 Object-program information  
 Encrypted data  
 Unedited information  
 etc.

Transparency is provided as a standard feature for EBCDIC and SBT. It is optionally available for USASCII.

#### Transmission-Code Checking

The error-detection circuitry for each transmission code is incorporated in the synchronous equipment. Automatic-checking capability is provided for the three transmission codes; however the checking method employed depends on the Synchronous Terminal Control and the kind of transparency chosen. Table II indicates the checking methods available.

Table II. Transmission-Code Checking

Synchronous Terminal Control	No Transparency	Transparency
EBCDIC	CRC <sub>16</sub>	CRC <sub>16</sub>
SBT	CRC <sub>12</sub>	CRC <sub>12</sub>
USASCII	VRC/LRC	VRC/CRC <sub>16</sub>

CRC = Cyclic Redundancy Check  
 VRC = Vertical Redundancy Check  
 LRC = Longitudinal Redundancy Check

VRC/LRC. This transmission-error-detection method consists of a combination of the vertical redundancy check (VRC) and longitudinal redundancy check (LRC). Thus, an odd VRC parity check is performed on each transmitted character including the LRC character. The LRC check is an even longitudinal check on the total data bits (not including parity) of the transmitted block of characters comprising the message block. The LRC is accumulated at both the sending station and the receiving station during the block transmission. This accumulated value becomes the block-check character (bcc). The transmitted bcc is automatically compared after ETX, ETB, or ITB with the bcc accumulated at the receiving station for an equal condition signifying correct receipt of the transmitted block.

VRC/CRC. This transmission-error-detection method consists of a combination of a vertical redundancy check and a cyclic redundancy check (CRC). The CRC checking makes use of a circuit-implemented polynomial that treats the transmitted message as a binary number, and performs modulo 2 divide operations on this binary number (carries are not considered). Both the sending and the receiving stations generate this value individually. The transmitting station sends its generated value resulting from the modulo 2 division. Only the remainder is transmitted to the receiving station, at which point the two CRC values are compared. Equal comparison indicates accurate transmission.

CRC. This checking method, as outlined above, may be used in place of the other listed checking methods. The two variations of the polynomial (CRC<sub>16</sub> and CRC<sub>12</sub> for eight-bit and six-bit codes respectively) are included in the publication, General Information-- Binary Synchronous Communications, Form A27-3004.

#### Synchronous Bases

Two versions of Synchronous Bases are available:

- Synchronous Base IA accommodates EBCDIC or USASCII at speeds up to 2400 bps.
- Synchronous Base IB accommodates SBT, USASCII, or EBCDIC at speeds up to 2400 bps.

Synchronous Base IA permits the attachment of up to 24 lines using EBCDIC or USASCII terminal controls and operating at bit rates not exceeding 2400 bits per second. This provides a character rate of up to 300 characters per second [(2400/8) = 300 characters]. Up to 600 digits per second can be transmitted in packed-decimal.

Synchronous Base IB permits the attachment of up to 16 lines using EBCDIC, USASCII, or SBT terminal controls and operating at bit rates not exceeding 2400 bits per second. This provides a character rate of up to 400 characters per second [(2400/6) = 400 characters] for SBT operation.

#### Synchronous Line Set

Synchronous communications facilities are attached to the 2703, modular by four, via a Synchronous Line Set. Each line set services up to four facilities (half- or full-duplex). The maximum number of line sets per Synchronous Base depends on the transmission code employed and whether the Synchronous Clock feature is provided.

These line sets provide for the attachment of up to four data sets. The following data sets, or equivalent, at speeds not exceeding 2400 bps, can be attached via the Synchronous Line Set without a Synchronous Clock feature:

- Western Electric Data Set 201A3 (2000 bps)
- Western Electric Data Set 201B1 (2400 bps)

**Synchronous Clock Feature.** This feature is supplementary to the Synchronous Line Set and provides for the attachment of up to four data sets (or IBM Line Adapters), where clocking for bit synchronization is not provided by the data set (or line adapter). This feature requires the installation of synchronous line speeds (see "Synchronous Line Speed Option"), and accommodates the following data sets (line adapters) or their equivalent:

- IBM 3977 Modem (WTC only)
- Western Electric Data Set 202C1
- Western Electric Data Set 202D1

Table III summarizes the number of synchronous lines that can be attached per 2703 by Synchronous Base.

#### Synchronous Line Speed Option

These options provide the pulses to drive the Synchronous Clock feature, which is required whenever the data set or line adapter does not provide timing or clocking pulses needed for external bit sampling. The Synchronous Line Speed Option is available for operation of the SF at 600, 1200, or 2400 bits per second for World Trade Corporation applications and at 1200 or 2400 bps for domestic use. Only one speed can be specified per Synchronous Line Set, and this speed is preset. If the Synchronous Clock feature is specified for one line, the other station(s) on the network serviced by this line must have the Synchronous Clock feature installed, and all stations must have the same bit rate.

#### Data Set (Modem) Features

A variety of transmission facilities can be attached to the BSC-adapted 2703, depending on the type facility used, transmission configuration, transmission speed employed, country of use, and so forth. Refer to Figure 13 for details.

**World Trade Corporation Communications-Interface Facilities.** The 2703 BSC can operate with the IBM 3977 Model 1 or Model 2 Modem on private leased, point-to-point common-carrier or privately owned facilities.

The 3977 Model 1 accommodates modulation rates up to 1200 bps. The Model 2 accommodates modulation rates up to 2400 bps.

Synchronous Base	Transmission Code	Number of Synchronous Line Sets without Synchronous Clock		Number of Synchronous Line Sets with Synchronous Clock	
		Base Mach.	Base Mach.	Base Mach.	Base Mach.
IA	EBCDIC, USASCII	6	12	3	6
IB	SBT	4	8	3	6

Table III. Synchronous Line Sets

#### Station-Selection Feature

The Synchronous Features in a 2703 may be operationally used as the BSC portion of a master station, or the SF may be used in a BSC-equipped multipoint network as a tributary (remote) station. The basic synchronous-equipped 2703 is designed to operate as a master station on a point-to-point basis; however, with the installation of the Station-Selection feature, a synchronous-equipped 2703 can be used as the tributary station--thus permitting a number of low-traffic-volume stations to be effectively combined to fully utilize the throughput capability of a multipoint line.

A multipoint network could typically be configured as shown in Figure 14.

The Station-Selection feature causes the elimination of interference that would otherwise be caused by interstation transmission on the line. Thus, the CPU (with a 2703 containing Station-Selection-adapted SF) is interrupted only when the SF's selection or polling address is received and transferred to main storage, at which point main storage can be interrogated for proper programmed action.

The Station-Selection feature is required when the SF is attached to a multipoint network and the station is operating as a remote (tributary) station and all transmission operations are directed to or from the central (master) station.

BSC-adapted stations can operate on the same multipoint line, provided they:

1. All use the same transmission code;
2. All utilize the same checking features;
3. All are able to handle, if not employ, the same optional features and special operations respecting their compatibility supplements;
4. All operate at the same line speed.

The Station-Selection feature implements two additional commands: Address Prepare (Adprep), and Search.

COUNTRY	Communication Facility	NETWORK CONFIGURATION	SPEED in Bits Per Second	DATA SET or MODEM
U.S.A. and Canada	Leased Voice Grade	Point-to-Point and Multi-Point	1200	W.E. 202D1* (A)
			2000	W.E. 201A3*
			2400	W.E. 201B1*
	Switched Telephone Network	Point-to-point	1200	W.E. 202C1* (A), (B)
			2000	W.E. 202D1 (A), (B), (C)
World Trade**	Leased Voice Grade	Point-to-Point	600/1200 Up to 2000	IBM 3977 Model 1 (A)
			Up to 2400 where required communications facilities are available	IBM 3977 Model 2 (A)
				IBM 3977 Model 2 (A)

NOTES

- \* Or equivalent.
- \*\* Must be approved by PTT Administrations.
- (A) Synchronous Clock feature required.
- (B) If Autocall feature is installed, W. E. Automatic Calling Unit 801A1 or 801C2 (or equivalent) is required. 801A1 serves rotary pulse dialing; 801C2 serves push button dialing. See common-carrier representative for type of dialing facilities available.
- (C) Requires Western Electric Data Auxiliary Set 804A1 (or equivalent)

Figure 13. Communications Facilities for BSC

BINARY SYNCHRONOUS COMMANDS

The BSC-equipped 2703 implements up to ten channel commands, depending on the optional features installed. These commands are:

Command	Command Code in Hexadecimal	Standard (S) or Optional (O)
Set Mode	23	S
Enable	27	S
Dial	29	O*
Write	01	S
Read	02	S
Prepare	06	S
Disable	2F	S
Poll	09	S
Address	1E	O**
Prepare		
Search	0E	O**

\*Requires Autocall feature  
 \*\*Requires Station-Selection feature

Set Mode

This command is used to condition the SF to the operating environment required. It results in the fetching of one byte of control information from main storage to the control circuitry of the SF.

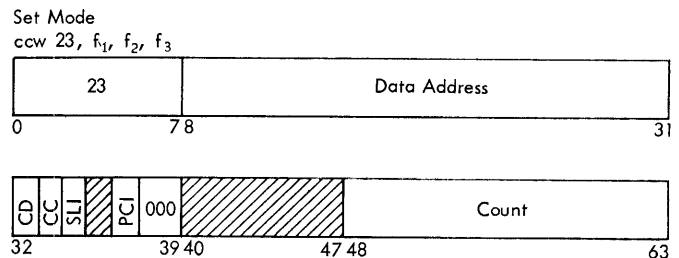

The bit positions of the byte fetched from main storage (its location is designated by the data-address field of the Set Mode CCW) are used as follows:

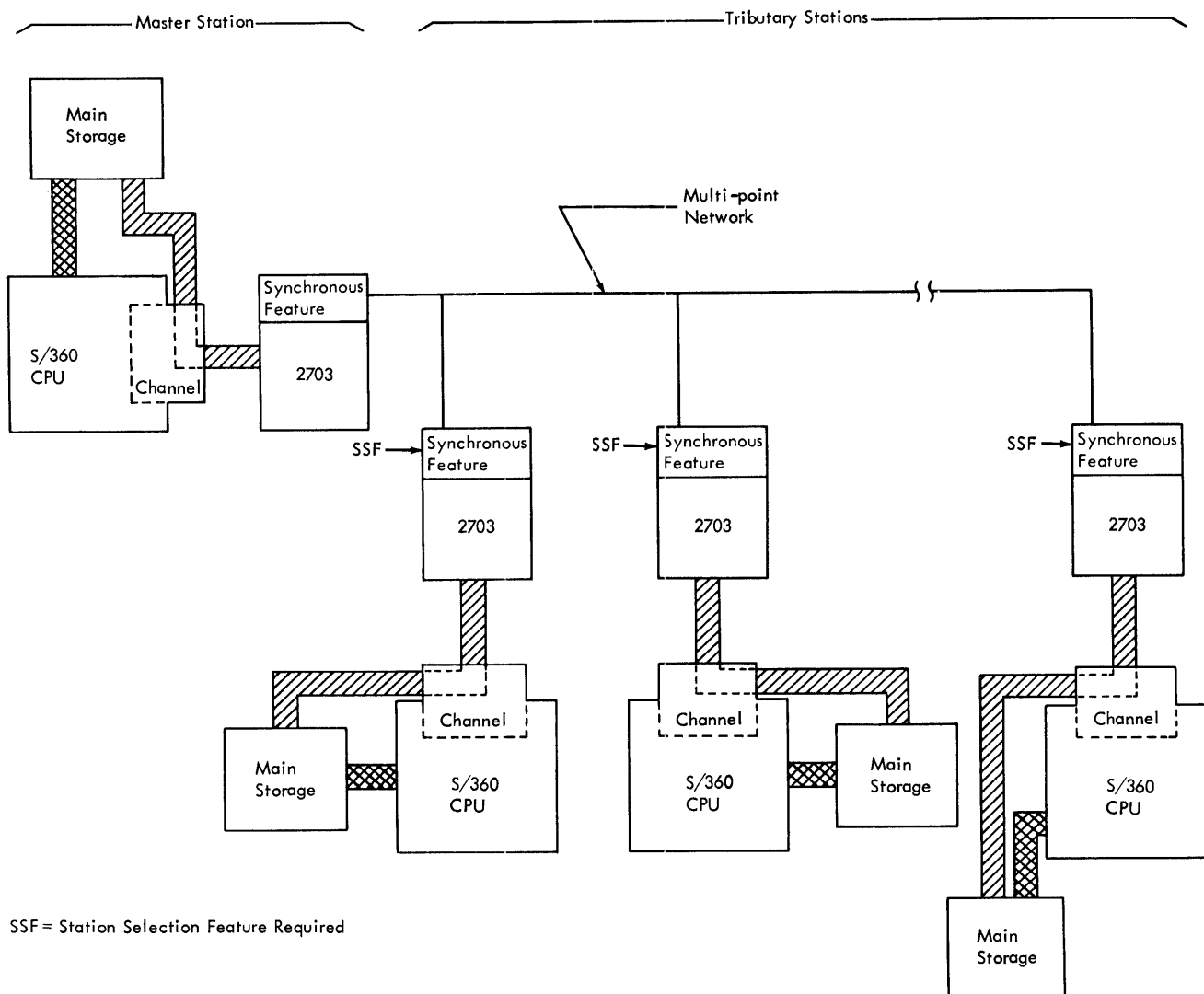

Figure 14. Multipoint Configuration

Bit Position	Use
0	Not used.
1	When set to 0, places SF in normal operation. When set to 1, the SF is placed in intermediate-block mode.
2 thru 7	Not used.

PROGRAMMING NOTE: After a power-on/power-off sequence or a system reset, the Set Mode command must be used to re-establish the operating conditions controlled by the Set Mode command.

### Enable

This command, preceded by a Set Mode command, turns the SF on and makes it operational with the selected data set or data station (depending on whether

Enable

ccw 27, f<sub>1</sub>, f<sub>2</sub>, f<sub>3</sub>

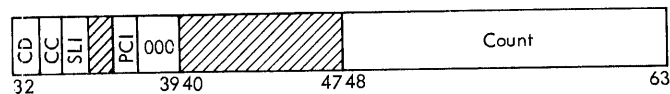
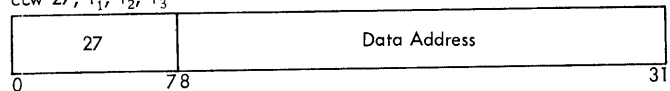



switched or private communications facilities are used). If the transmission is to be via private line, the command ends immediately, upon enabling the SF and the line, with Channel End and Device End status (CSW bits 36 and 37).

If the transmission is to be via switched network, the command ends with Channel End and Device End status when the local data set is operationally available.

This command permits the SF to be in condition to answer dialed "calls" from remote station, if required. No data is transferred in either direction by this command.

### Dial

This command permits automatic dialing of a remote BSC-equipped station. If the Autocall feature (ACF) is not installed, the Dial command will be rejected

Dial  
ccw 29, f<sub>1</sub>, f<sub>2</sub>, f<sub>3</sub>

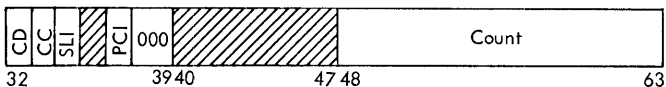
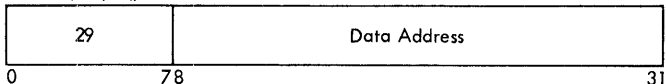

with a Command Reject (sense-bit 0 set to one) and will also result in setting Unit Check status (CSW bit 38). When Dial is executed, bytes are transferred from main storage to dial equipment (provided by common carrier) at a data rate determined by the dial equipment.

The transferred bytes represent the dial digits required for switching purposes. All dial codes are regarded as decimal digits and are stored in main storage, one dial digit per byte location. The SF does not check if the characters transmitted under a Dial command are valid dial digits, as only the four low-order bits of the dial-digit byte are transferred to common-carrier equipment.

The Timeout sense bit (bit 7) is set to one if the common-carrier equipment does not signal the ACF of successful completion of the dial operation within the recommended 40 seconds. This timeout duration is initiated by the transmission of the last dial digit to the common-carrier equipment. The command is immediately ended with Channel End, Device End, and Unit Check status (CSW bits 36, 37, and 38).

Successful completion of the Dial command results in Channel End and Device End status (CSW bits 36 and 37).

The Dial command can be command chained (CCW bit 32 set to one) to a Write or Read command. At

the completion of the data communication with the remote station, the dial operation is normally terminated by the issuance of the Disable command.

If the Automatic Calling Unit is nonoperational, sense-bit 1 (Intervention Required) is set to one and the command is ended with Channel End, Device End, and Unit Check status (CSW bits 36, 37, and 38).

### Disable

This command is used to reset the line; i. e., it deconditions the enabling of the line originally provided by the Enable command.

Disable  
ccw 2F, f<sub>1</sub>, f<sub>2</sub>, f<sub>3</sub>

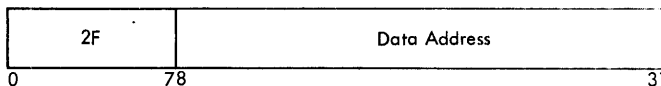

If operating on a switched network, the execution of the Disable command terminates an outstanding call. If operating on a private line, this command ends immediately with Channel End and Device End status (CSW bits 36 and 37).

When disabled, the line will not answer any incoming calls. Note that, following a Disable command, a Set Mode command must be issued before enabling or dialing.

### Prepare

This command may be used in contention-type communications systems to indicate when data is arriving and to thus monitor the received data stream

Prepare  
ccw 06, f<sub>1</sub>, f<sub>2</sub>, f<sub>3</sub>

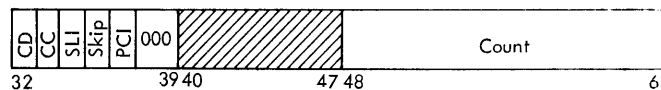
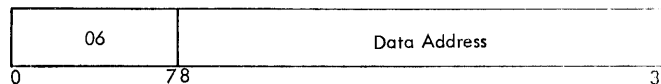

for SYN characters. The Prepare command will be accepted only if the line has been previously enabled. No data transfer to main storage occurs during the Prepare command execution.

The Prepare command ends when a sync pattern has been detected and sets the Channel End and Device End status (CSW bits 36 and 37).

A Read command should be command chained to the Prepare command in order to transmit any ensuing data to main storage. Any SYN characters assembled by the 2703 are not transferred to main storage.

The Prepare command should not normally be used in switched-network operation, because no timeouts are performed to protect the system against hang-up.

### Write

This command is used to transfer information from main storage to the remote station. The length of the information, in bytes, is determined by the

Write  
ccw 01, f<sub>1</sub>, f<sub>2</sub>, f<sub>3</sub>

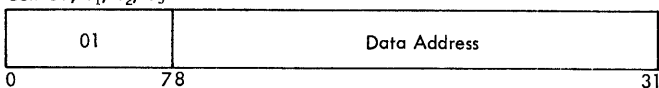

count field of the CCW each time the write command is issued. A single "pad" (all ones) and two SYN characters (except in transparent mode) will be presented to the communications line prior to the first character. If the Synchronous Clock feature is installed, six SYN characters are presented before the first character. All data or control characters that are transmitted to the communications line must be originated in main storage (except DLE and SYN when used as time-fill). The Write command will end as a result of any of the following conditions:

- a. An ETX or ETB control character is detected in the data stream (except in transparent mode).
- b. The 2703 detects common-carrier-equipment malfunction.
- c. Count field in Write CCW is decremented to zero.

At the end of the Write command, a single pad character is automatically sent after the last character of block-check character (bcc) to ensure that the data set will have time to transmit the last character before data-set turnaround.

PROGRAMMING NOTE: All Write commands will normally have bit 33 set to one for command chaining to a Read command to prevent loss of data. An exception to this requirement is when the Write command is used for sending EOT to a remote station.

### Read

This command is used to transfer characters from a BSC-equipped remote station to main storage. For characters to be transferred to main storage,

Read  
ccw 02, f<sub>1</sub>, f<sub>2</sub>, f<sub>3</sub>

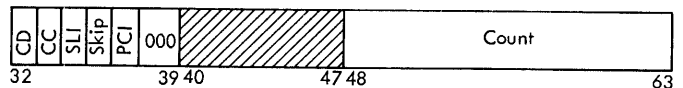
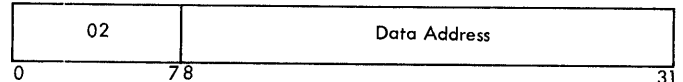

the line must be in character phase (i. e., must have received a SYN character). On a read operation, the bcc and all SYN characters are deleted in the 2703 prior to transfer to main storage.

The Read command will end normally with Channel End and Device End status (CSW bits 36 and 37) when any ETB, ETX, ACK, NAK, DLE (and associated ending follower characters), or ENQ characters are detected. If an EOT is detected, the Read command will end with Channel End, Device End, and Unit Exception status (CSW bits 36, 37, and 39).

The Read command will end with Channel End, Device End, and Unit Check status (CSW bits 36, 37, and 38) should the following conditions occur:

Condition	Sense bit set
Count decremented to zero	6
Halt I/O issued	6
Data check occurs	4
Overrun occurs	5
Common-carrier equipment not operational	1

NOTE: Sense-bit 6 is also set to one if data is lost because the Read command was late in being executed.

If the time interval between the sequences of signal SYN's followed by a non-SYN character is greater than three seconds, or if the time interval between the acceptance of the Read command and the receipt of either SOH or STX or an End character (any of those mentioned) is greater than three seconds, the command will be ended with Channel End, Device End, and Unit Check status (CSW bits 36, 37, and 38) and the Timeout sense bit (bit 7) set to one.

## Read and Write Operations in Transparent Mode

Transparent mode is used during reading and writing operations of text transmitted in "bit-pattern structure" rather than "character-pattern structure" as in normal mode.

Transparent-Read Operation. The SF enters transparent mode via the control-character sequence DLE STX. SF exits from the transparent mode of operation by the detection of a DLE followed by any end control character (ACK, NAK, ETX, ETB, ENQ, EOT, or ITB). A DLE followed by a non-ending control character results in the SF remaining in transparent mode and in the setting of sense-bit 4 (Data Check) to one. A DLE DLE sequence causes the SF to remain in transparent mode with the first DLE deleted from the data sent to main storage, as is every first DLE in transparent mode.

Transparent-Write Operation. Transparent-write operations require two Write commands to be executed. The first Write command is used to transmit the data stream and is ended normally when the byte count equals zero. The command-chained second Write causes the SF to leave transparent mode when one of the following sequences is detected during the second Write command execution--DLE ETB, DLE ETX, or DLE ITB. The command ends with Channel End and Device End status. If none of these sequences occur, the byte count of the second Write command (CCW), when decremented to zero, causes the command to end and the SF leaves transparent mode. Channel End and Device End status are set.

The second Write command must be received by the SF within three seconds of the ending of the first Write command; otherwise a timeout occurs with Channel End, Device End, and Unit Check status and the Time sense bit (bit 7) set to one.

During transparent operations, the SF generates a DLE character whenever it detects a transparent-text-bit configuration that is the same bit configuration as a DLE character. This insertion of a DLE prevents the receiving station from falsely ending a block if the transparent-bit configuration is the same as a transparent-ending sequence (e. g., DLE ETX). The inserted DLE is deleted by the receiving station prior to placing the received message in the receiving station's main storage.

To permit a bona fide ending sequence to be transmitted, the transmitting SF must know when to inhibit the insertion of the DLE character under the conditions just cited. This is accomplished by the use of the two Write commands as follows.

The byte count of the first Write command is decremented to zero upon the transmission of the last byte (character) of the message. The second Write is command chained to the first Write command, with the second Write command containing the ending sequence. Thus the SF recognizes the ending of the first Write command as the initiation of the ending sequence provided by the second Write. Under this second Write command, the SF does not generate a DLE upon detection of a main-storage-provided ending sequence. See Figure 15.

**PROGRAMMING NOTES:** For both read and write operations, a DLE ITB sequence causes the SF to exit from transparent mode, yet continue in text mode

The SF sends the block-check-character accumulation after ETB, ETX, or ITB.

The DLE SYN sequence is used in transparent mode in the same manner that the SYN is used in nontransparent mode. The DLE SYN sequence is not recommended for use as time-fill.

In transparent operations, no VRC checking follows the initial DLE STX sequence except on control characters.

The DLE ITB sequence is followed by the bcc SYN SYN (double SYN generated by the equipment) sequence. If the data following is to be in transparent mode, the DLE STX sequence must follow the SYN characters. In this case, the DLE and STX characters are included in the bcc accumulation since the SF does not leave text mode via the ITB character when the SF is in intermediate-block mode.

## Search

This command is used when the synchronous-equipped 2703 is operating as a master station. The Search command may be issued only after a Poll command.

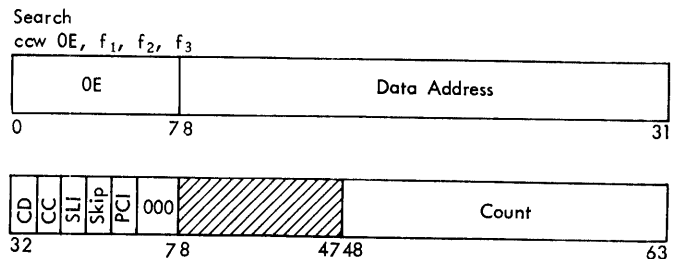

Since the SF will normally be in character phase when the Search command is issued, data will be immediately transferred to main storage, starting with the last index character 9 sent from main storage under the preceding Poll command). The last index character is followed by the data being received from the communications line.

All data received before going into text mode (entry into text mode via recognition of the STX or SOH--including the first STX or SOH) is sent to main

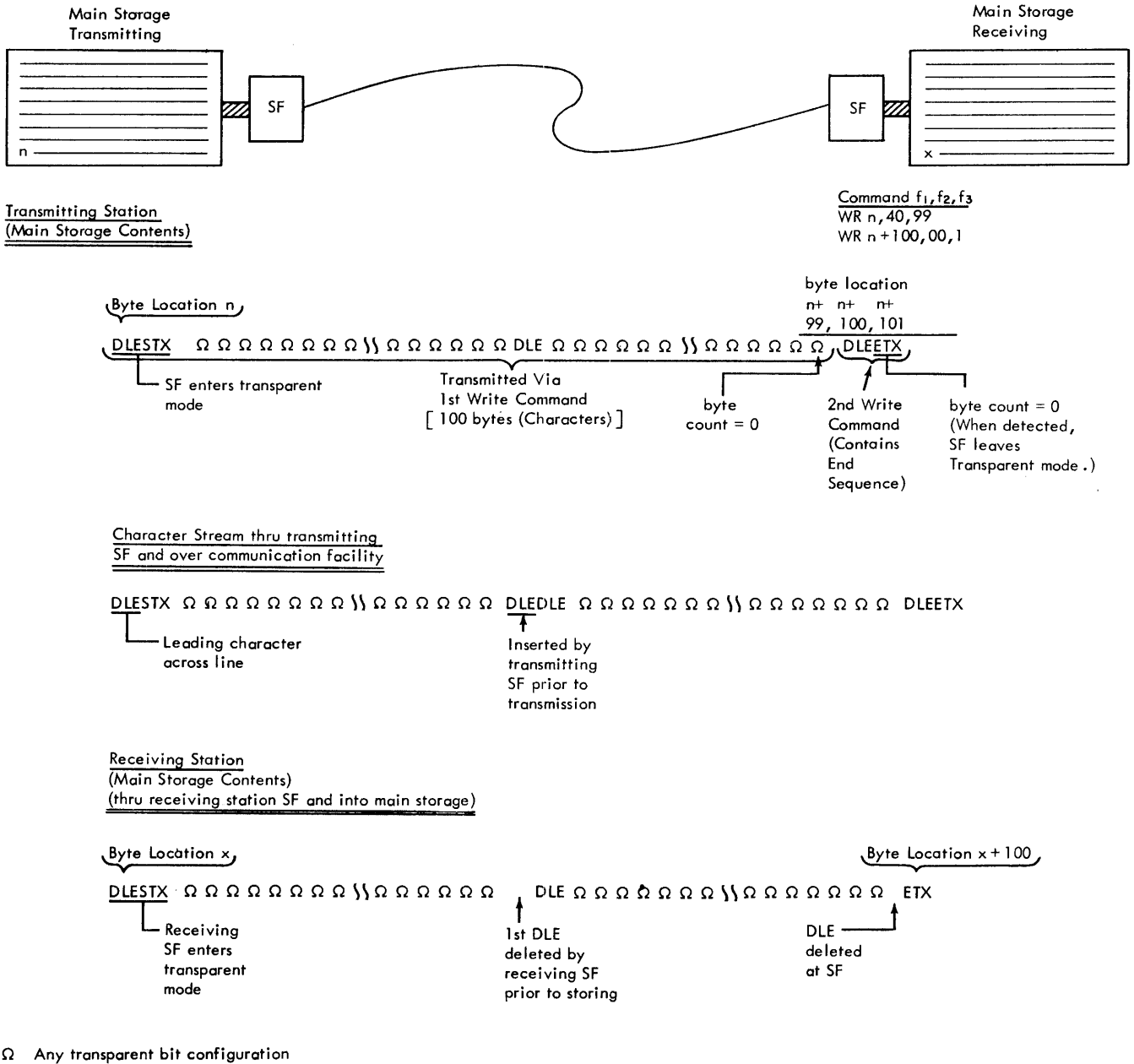

Figure 15. Transparent Operation

storage. Before going into text mode, the one-second timeout is utilized and the timeout condition is reset every time a new End character, STX or SOH, is detected. If the one-second-timeout condition is recognized before entry into text mode, the Search command ends with Channel End, Device End, and Unit Check status (CSW bits 36, 37, and 38) and the Timeout bit (sense-bit 7) set to one. While in text mode, no data is sent to main storage and the SF monitors all data and responses. The

Search command ends with Channel End, Device End, and Unit Exception status (CSW bits 36, 37, and 39) upon recognition of an EOT character, or with Channel End, Device End, and Unit Check status (CSW bits 36, 37, and 38) and the Timeout sense bit (bit 7) set to one if the three-second timeout occurs after entering text mode.

If the first non-SYN character received as a response to a Poll command was a master-station address, the Search command chained to the Poll

command ends normally when the ENQ is detected. All conditions pertaining to the Read command apply to the Search command under this circumstance.

PROGRAMMING NOTE: No fast-selection operation is permitted with the Search command.

### Address Prepare

This command (Adprep) is used by the tributary station equipped with the Station-Selection feature. The Adprep command is a pseudo-Read command in

Address Prepare  
ccw 1E, f<sub>1</sub>, f<sub>2</sub>, f<sub>3</sub>

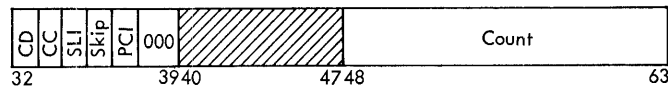
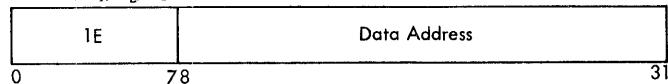

that the SF goes through all the actions of a Read command, yet does not transfer data to main storage.

When the SF accepts the Adprep, the SF monitors the receive line, following all data on the line. If the Adprep command is accepted and character phase is not established (the SYN pattern has not been detected), the SF starts a three-second timeout, during which it must recognize SYN followed by one of the following three conditions:

- a. 2703 Address--If a selection address is detected, the command will end with Channel End and Device End status (CSW bits 36 and 37), thus allowing chaining to a Read command; or if the polling address is detected, the command ends with Channel End, Device End, and Status Modifier status (CSW bits 36, 37, and 33 respectively). This allows command chaining to a Read command other than the Read command used when the selection address is detected.
- b. Text-Mode Entry--Upon entering into text mode (as a result of recognizing STX or SOH), the SF will cease looking for its address until a new SYN SYN EOT sequence is detected. The SF monitors the data stream while in text mode, using the three-second timeout for recognition of SYN characters ... similar to the Read command operation, but with the exception that the Address Prepare command does not end.
- c. End-Character Recognition--The recognition of a new SYN SYN and an End character will cause the three-second timeout to be reinitiated, and the SF will continue to monitor for

a new SYN SYN and its address or an End character.

If a timeout occurs or if sync is established when the Adprep command is issued, the SF looks for a SYN SYN EOT sequence before any of the preceding conditions are sought.

The SF decodes up to three addresses. The addresses are known as the group address, the poll address, and the selection address.

The group address is used when a station wishes to receive a transmission as part of a group of stations, with one of the group of stations pre-designated as the responding station.

The poll address is the address of the tributary station used in a polling operation (transmitting), while the selection address is used as the address of the tributary station in a selection operation.

### Poll

This command is a pseudo Write command in that the SF goes through the actions of a normal Write command until the ENQ control character is detected

Poll  
ccw 09, f<sub>1</sub>, f<sub>2</sub>, f<sub>3</sub>

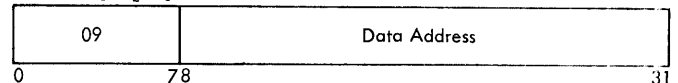

in the data received from main storage. The index character should always follow ENQ, and this index will be the first character sent to main storage when the positive response is received. After the ENQ has been transmitted to the line, the SF enters receive mode (however, Channel End and Device End are not sent to main storage). When in receive mode, the SF looks for the receipt of character phase. The following conditions may occur:

- a. Timeout--Following the transmitting of the ENQ, a three-second timeout is initiated. At the end of three seconds, if the SF is not in character phase, the Poll command ends with Channel End, Device End, and Status Modifier status (CSW bits 36, 37, and 33).
- b. Recognition of Character Phase--Upon receipt of character phase, the operation ends with Channel End, Device End, and Status Modifier status if the first non-SYN character following recognition of character phase is not an EOT character. If the first non-SYN character is an EOT, the SF returns to transmit mode and transmits the next character immediately

following the last index character. Additional characters are requested when required. The old index character is destroyed.

When the CSW receives the Status Modifier signal, the Poll command should then chain to either a Read or a Search command (depending on whether operating as point-to-point or multipoint). The first character received during the Read or Search command execution is the last index character sent out from main storage in the previous Poll. After the index character has been transferred to main storage, the SF immediately sends to main storage the data received via the communications line. If the Timeout sense bit had been set during the Poll command execution, the SF ends the command chained to Read or Search with Channel End, Device End, and Unit Check status and with the Timeout sense bit set to one.

**EFFECT OF HALT I/O INSTRUCTION AND ZERO BYTE COUNT**

All the commands implemented by the Synchronous Base employ a command structure as follows:

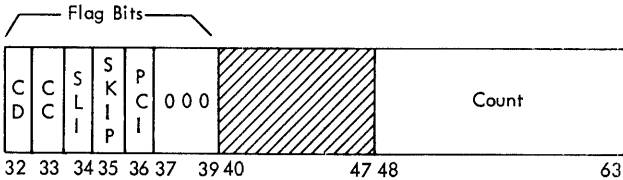
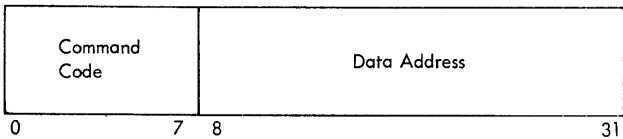

A complete discussion of each of the fields within a channel-command word (CCW) is included in the publication, IBM System/360, Principles of Operation, Form A22-6821.

When the byte count in the current CCW is decremented to zero, and data chaining is not specified (bit 32 set to zero), a condition known as interface stop occurs in the event additional bytes are requested. This condition signals the 2703 that no additional bytes are to be transferred between main storage and the 2703.

Various actions take place, depending on the command being executed, as follows:

<u>Command</u>	<u>Action</u>
Set Mode	Command ends when stop is signaled. If no error or unusual condition occurred during execu-

tion, the ending status is Channel End and Device End status (CSW bits 36 and 37).

**Dial**

Stop indicates the last dialing digit has been transferred. After the last dialing digit has been transferred to common-carrier dial equipment, the Auto-call feature will wait for a signal from the data set indicating that the connection to the remote station has been established. Command ends with Channel End and Device End status (CSW bits 36 and 37).

If the call cannot be answered at the remote station, the Dial command ends with Channel End, Device End, and Unit Check status (CSW bits 36, 37, and 38) and the Timeout sense bit (bit 7) set to one.

**Read**

The Interface Stop signal causes the command to immediately cease transferring data to the channel. The Unit Check status (CSW bit 38) and the Lost Data bit (sense-bit 6) are set to one. Since any data that has been read but not transferred to main storage will not be transferred, part of the received data will always be lost as a result of an Interface Stop signal.

**Write**

Stop signal indicates the last character has been transferred under the current command. The SF sends any characters it has buffered to the line and ends with Channel End and Device End status (CSW bits 36 and 37). The SF goes into receive mode after transmitting the last character: If the SF was operating in transparent mode, it will continue in transparent synchronism by sending transparent sync idles until another Write command is issued. This new Write is used to transmit the end-of-transparent-block (DLE ETB) or end-of-transparent-text (DLE ETX) sequence.

Search	The Interface Stop causes the command to cease transferring data to the channel and stop monitoring for valid addresses. Unit Check status (CSW bit 38) and Lost Data (sense-bit 6) are set to one. Part of the received data will always be lost when the Interface Stop occurs.	Enable	times, it has no effect on the Set Mode command's execution.  On a switched network, if the HIO is received when the data set is not operational (i. e. , before the call has been answered), the command is ended with Channel End, Device End, and Unit Exception status (CSW bits 36, 37, and 39). Otherwise, HIO has no effect on the normal execution of the Enable command and the SF is not reset.
Poll	The stop signal indicates that the last character (EOT) has been transferred from main storage to the SF under the current Poll command. The SF sends any buffered characters and ends the command with Channel End and Device End status (CSW bits 36 and 37). The SF waits for the reply to the poll operation before ending the command. Note that the program must ensure that the byte count is exactly as large as the poll list so that the last character transferred by the Poll command is index character for the last poll in the list.	Dial	An HIO received before the Interface Stop signal has been transmitted to the SF (e. g. , the entire number has not been dialed) results in aborting the dialing operation, the resetting of the enable and dial circuitry, and the immediate ending of the command with Channel End, Device End, and Unit Exception status (CSW bits 36, 37, and 39). If HIO is received after the Interface Stop signal has been received, the dialing operation proceeds normally.
Enable, Disable, Adprep, Prepare	No data-byte transfers occur with execution of these commands; accordingly, Interface Stop is never signaled.	Write	HIO causes the SF to transmit any currently buffered characters and then terminate the command.
Sense	The Interface Stop signal causes this command to end immediately with Channel End and Device End status (CSW bits 36 and 37).	Read	HIO causes the command to stop transferring data to the channel. The Unit Check status (CSW bit 38) and Lost Data (sense-bit 6) bits are set to one. Part of the data will always be lost when the HIO is issued during a Read command execution. The command ends immediately.

Halt I/O Instruction

A Halt I/O (HIO) instruction can be issued to the 2703 during the execution of a command. When HIO is issued, various actions take place, depending on the command being executed:

<u>Command</u>	<u>HIO Action</u>		
Set Mode	If HIO is received before the Set Mode byte has been accepted from main storage, the command ends immediately with Channel End, Device End, and Unit Exception status (CSW bits 36, 37, and 39). The SF is reset. If HIO is issued at other	Prepare	If HIO is issued before character phase is established, the command ends immediately with Channel End, Device End, and Unit Exception status (CSW bits 36, 37, and 39). If HIO is issued after character phase has been established, there is no effect.

Adprep	If HIO is issued before the group, selection , or polling address is recognized, the command ends immediately with Channel End, Device End, and Unit Exception status (CSW bits 36, 37, and 39). Otherwise, the operation is not affected.	Poll	HIO causes the command to end immediately with Channel End and Device End status (CSW bits 36 and 37). HIO should not be used with the Poll command.
		Disable	The HIO instruction has no effect on the Disable command.
Search	HIO causes the cessation of data transfer to main storage. Unit Check status (CSW bit 38) and Lost Data (sense-bit 6) are set to one. The command ends immediately. Part of the data will be lost when the HIO is issued.	Sense	HIO causes this command to end immediately with Channel End and Device End status (CSW bits 36 and 37).



## APPENDIX A. OPERATOR'S CONTROL PANEL

The operator's control panel (Figure 16) contains the following indicators and switches.

### INDICATORS

#### Power On

ON when dc power is ON (combination light and switch).

#### CB

On when a power-supply circuit breaker is tripped.

#### Thermal

ON when any thermal unit is tripped (turns dc OFF).

#### CE Test

ON when CE Test switch is ON.

#### Meter

Indicates elapsed running time of the unit.

### SWITCHES

#### Power On

Turns on dc power (see "Note").

#### Pwr Off if in Local

Turns off dc power (see "Note").

#### Meter

In OFF position, the 2703 unit goes off-line.

#### Partition--CPU 1, CPU 2

These two switches are associated with the Two-Processor Switch special feature.

ON. This permits the associated CPU to be attached to the 2703. (Refer to the Two-Processor Switch special feature.)

OFF. The associated CPU is partitioned (cut off) from the 2703.

NOTE: 2703 Power-On/Power-Off Considerations--With a program running in the CPU, turning 2703 power ON or OFF may cause machine (CPU) checks (interruptions). If the CPU is temporarily placed in a wait state before actuating the 2703 Power On switch, this condition can be averted. The CPU must be returned to the running state after the power-switch actuation to resume operations.

### METERING

The 2703 usage meter will run when:

1. The 2703 is on-line and the CPU is not in a halt or wait state;
2. The CPU is in a halt or wait state but the 2703 is performing active work;
3. Any control unit on the same channel is performing active work.

"On-line" means that 2703 power is ON and the 2703 Meter switch is set to the ON position.

The 2703 is performing active work when any of its lines are under control of any command other than the Enable or Prepare commands.

If the 2703 Meter switch is changed to the OFF position while the CPU is not in a halt or wait state, the 2703 meter continues to run until the CPU is in a halt or wait state and the 2703 is command free.

If the CPU is in a halt or wait state and the 2703 meter is running as a result of another control unit on the same channel performing active work, changing the 2703 Meter switch to the OFF position causes the 2703 meter to stop immediately.

#### Metering with the TPS Feature

The Two-Processor Switch (TPS) feature influences the operation of the 2703 usage meter as follows:

1. The 2703 raises Metering In only when the 2703 is attached to one of the two channels.
2. The 2703 usage meter runs when the Metering Out line from the attached processor is raised. Table IV defines the operation of the 2703 usage meter for the various partition situations. This table assumes that for each situation (partition-switch setting) that the necessary conditions are present (i. e., wait state, command free). When the Partition switch is positioned to OFF, the associated CPU is partitioned (cut off).
3. The 2703 usage meter will also run when the TPS is neutral and the Metering Out lead from either non-partitioned CPU is active.

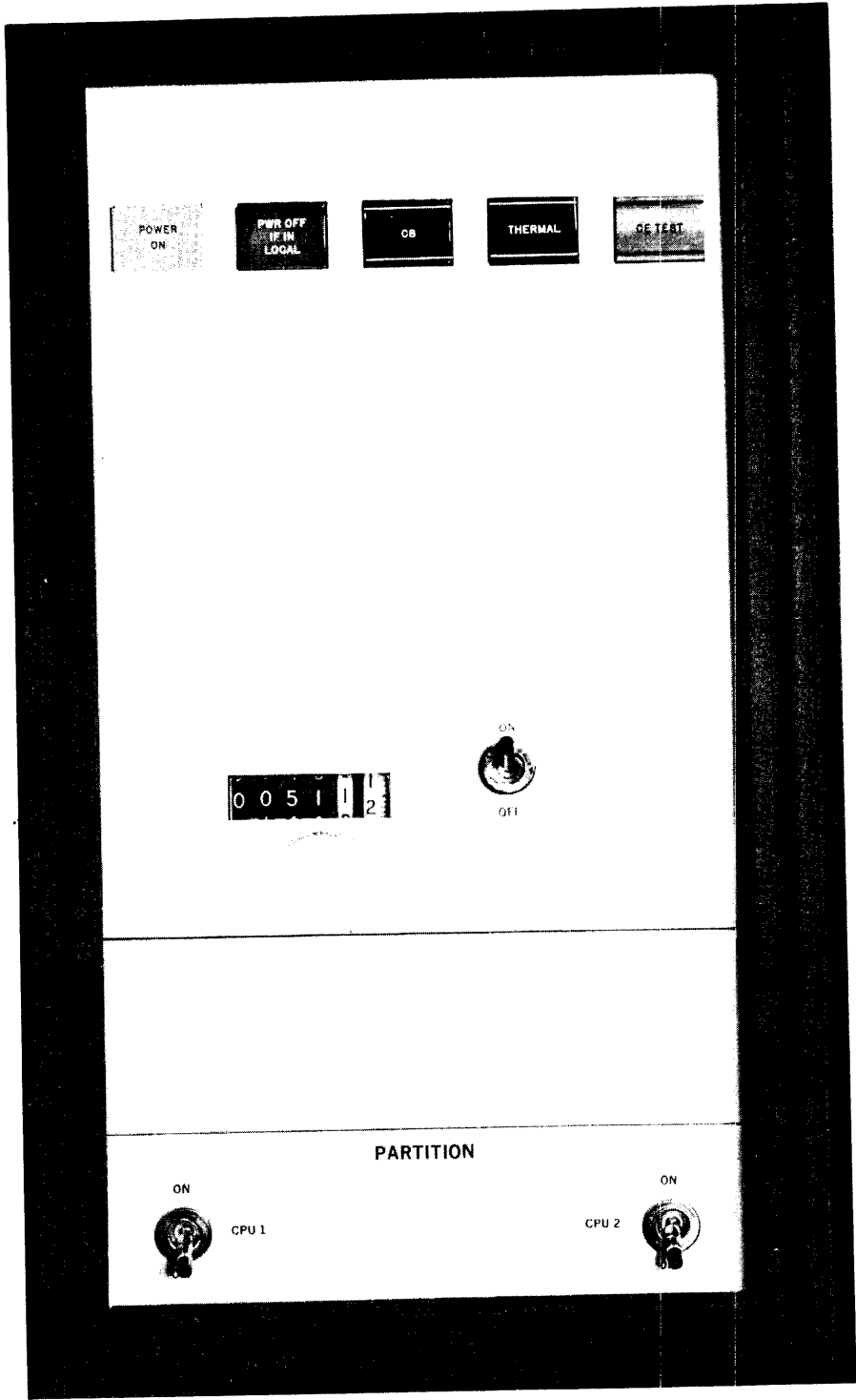

Figure 16. Operator's Panel

Table IV. Meter Operation under Various TPS Conditions

Switch Position			TPS State	Meter is Running when Metering Out is Active for
CPU 1	CPU 2			
ON	ON		Neutral CPU 1 attached CPU 2 attached	CPU 1, or CPU 2 CPU 1 only CPU 2 only
OFF	ON		Neutral CPU 2 attached	CPU 2 only CPU 2 only
ON	OFF		Neutral CPU 1 attached	CPU 1 only CPU 1 only
OFF	OFF		Neutral	Meter is never active regardless of Metering Out from either CPU 1 or CPU 2.

NOTES:

1. Metering-In. Metering-In is a line from all attached control units and is used to condition the CPU meter for operation. The Metering-In signal originates from each I/O device and/or control unit and is generated by the device from the time of acceptance of a command until the generation of Device End for that command.

2. Metering-Out. Metering-Out is a line from the channel to all attached control units and is used to condition all meters in assignable units and I/O units. Metering-Out is raised whenever the CPU meter is recording time.

## APPENDIX B. COMMUNICATIONS FACILITIES

The 2703 operates in half-duplex mode over:

- Common-carrier switched telephone network.
- Common-carrier switched 150-baud Teletypewriter Exchange (TWX) network
- Common-carrier leased private-line telephone service
- Common-carrier leased private-line telegraph service
  - a. Telephone Company Type 1002 and 1005 Private-Line Service (formerly Schedule 1, 2, and 3 channels)
  - b. Western Union Class A, B, or C channels
  - c. Telephone Company 150-baud Type 1006 Private-Line Service (formerly Schedule 3A channels)
- Western Union Class D (180-baud) channels
- Western Union Class E channels
- Western Union Class F channels
- Equivalent privately owned communications facilities

### COMMON-CARRIER-PROVIDED FACILITIES

#### Common-Carrier Switched Telephone Network

1. At 134.5 bps, a Western Electric Data Set 103A2\* is required for each line equipped to answer calls from asynchronous terminal devices.
2. At 1200 bps, a Western Electric Data Set 202C1,\* or a combination of a 202D1\* with a Data Auxiliary Set 804A1,\* is required for each line equipped to answer calls from synchronous terminal devices.
3. At 2000 bps, a Western Electric Data Set 201A3\* is required for each line equipped to answer calls from synchronous terminal devices.
4. For each line arranged to automatically originate calls, a Western Electric Automatic Calling Unit 801A1\* or 801C2\* is required in addition to the data sets in items 1, 2, and 3.

NOTE: Automatic answering is available on each of the data sets above.

---

\*or equivalent

#### Common-Carrier Switched Teletypewriter Exchange (TWX) Networks

1. For communications with common-carrier TWX stations (Model 33/35 type) at 110 bps, a Western Electric Data Auxiliary Set 811B1\* is required on each line equipped to answer calls.

NOTE: A common-carrier TWX station must be provided with the first 811B1\* unit at each site.

2. For communications with start/stop terminal devices at 134.5 bps, a Western Electric Data Set 103A1\* is required on each line equipped to answer calls.
3. In items 1 and 2 preceding, on lines equipped to automatically originate calls, a Western Electric Automatic Calling Unit 801A1\* or 801C2\* is also required for each line.

#### Common-Carrier Leased Private-Line Telephone Service

1. At 134.5 bps, either a suitable IBM Line Adapter, an IBM 2711 Line Adapter Unit equipped with a suitable IBM Line Adapter, or a Western Electric Data Set 103F2\* is required for each line (see "Note").
2. At 600 bps (start/stop four-wire), either a 2711 equipped with a suitable IBM Line Adapter or a Western Electric Data Set 202D1\* is required for each line (see "Note").
3. When connecting to a 2712 Remote Multiplexer Model 1, a four-wire full-duplex Type 3004 Private-Line Service (formerly Schedule 4, Type 4B channel) and a Western Electric Data Set 202D2\* are required; when connecting to a 2712 Model 2, a four-wire full-duplex Type 3003 Private-Line Service (formerly Schedule 4, Type 4A channel) and a Western Electric Data Set 202D2\* are required. In either case, alternate voice-data capability with key-controlled ringing is recommended. The Data Set 202D2\* must be wired and equipped by the local common carrier to provide full-duplex data operation and a one-way, low-speed reverse channel to accommodate signals transmitted from the 2703 to the 2712. This wiring

---

\*or equivalent

arrangement must be ordered by the customer at the time he places his data set order.

NOTE: Where the line conforms to the specifications in the SRL manual A24-3435\*\* for Limited-Distance Line Adapter Type 1, the IBM Line Set 1A (#4686) or 1B (#4687) can be used in place of a data set for attachment of 2740 or 2741 terminals. Where the line conforms to specifications in the cited manual for Limited-Distance Line Adapter Type 2, the IBM Line Set 2 (#4688) can be used to attach IBM 1030, 1050, 1060, 1070, 2740, and 2741 systems and terminals.

4. For each line servicing synchronous terminal devices, the following is required:
  - a. At 1200 bps (synchronous), a Western Electric Data Set 202D1\* is required.
  - b. At 2000 bps, a Western Electric Data Set 201A3\* and Type 3004 Private-Line Service (formerly Schedule 4, Type 4B) or better are required.
  - c. At 2400 bps, a Western Electric Data Set 201B1\* and Type 3004 Private-Line Service or better are required. For operation at 2400 bps using Western Electric Data Set 201B1\* on Type 3004 Private-Line Service, there are additional restrictions and limitations to the facility and operations. See the SRL manual, General Information--Binary Synchronous Communications, Form A27-3004, for details.

#### Common-Carrier Leased Private-Line Telegraph Service

1. On Telephone Company Type 1002 or 1005 Private-Line Service (formerly Schedule 1, 2, or 3 channels) and Western Union Class A, B, or C channels, common-carrier data sets are not required. However, a 62.5-milliampere neutral dc loop must be provided by the common carrier for each telegraph channel where operation is via the Telegraph Line Set (#7897).

\*or equivalent

\*\*Form A24-3435-2, or subsequent revisions

2. On Telephone Company 150-baud Type 1006 Private-Line Service (formerly Schedule 3A channels), appropriate channel termination must be provided by the common carrier as required by local conditions, where connection to the channel termination is via a Data Line Set.

#### Western Union Class D (180-Baud) Channels

1. A Western Union Data Loop Transceiver 1183A\* is required for each channel termination.

#### Western Union Class E Channels

1. An IBM Line Adapter (#4639 for two-wire, or #4647 for four-wire) on a 2711 Line Adapter Unit is required for each start/stop channel termination. For operation at 1200 bps (synchronous), a data set with an appropriate EIA RS 232B interface is required for each channel termination.

#### Western Union Class F Channels

1. At 2400 bps, a data set with an appropriate EIA RS 232 interface is required for each line servicing synchronous terminals.

NOTE: For operation at 2400 bps with WU Class F channels, there are additional restrictions and limitations to the facility and operations. See the SRL manual, General Information--Binary Synchronous Communications, Form A24-3004, for details.

#### PRIVATELY OWNED COMMUNICATIONS FACILITIES

The privately owned communications facility must be equivalent to one of the previously described common-carrier facilities. If the facility conforms to the SRL manual A24-3435\*\* specifications for Limited-Distance Line Adapter Type 1, IBM Line Set 1A or 1B (#4686 or #4687) may be used; for Limited-Distance Line Adapter Type 2, IBM Line Set 2 (#4688) may be used in place of data sets.

\*or equivalent

\*\*Form A24-3435-2, or subsequent revisions



- Address Assignment Considerations 13
- Address Boundaries 13
- Address Range 13
- Addressing Characters 23
- All Zeros (Normal) 29
- Assemble/Disassemble Field 16
- Attached Communication Lines 5
- Attention Key (2741) 45
- Auto-Call Feature 21
- Automatic Answering 21
- Automatic Wraparound 15
  
- Base Expansion Feature 36
- bcc (Block-Check Character) 48
- Binary Synchronous Commands 55
- Bit Count 16
- Break 25
- BSC (Binary Synchronous Communications) Capabilities 47
- BSC Special Features 51
- Bus Out Check (2-Bit), Sense Byte 31
- Busy, Status Modifier, and Control Unit End 29
  
- CAW (Channel Address Word) 11
- CB Light 65
- CC (Chain Command) 15
- CCW (Channel Command Word) 11
- CD (Chain Data Flag) 15
- CE Test Light 65
- Channel Attachment Restrictions 14
- Channel End and Device End 29
- Channel End, Device End, and Status Modifier 30
- Channel End, Device End, and Unit Check 30
- Channel End, Device End, and Unit Exception 30
- Channel End, Device End, Unit Exception, and Unit Check 30
- Character Address 16
- Character Recognition Summary 41, 42, 43
- Command 18
- Command Reject (0-Bit), Sense Byte 31, 32, 33, 34
- Commands, Start/Stop 25, 26
- Common-Carrier Leased Private-Line Telegraph Service 69
- Common-Carrier Leased Private-Line Telephone Service 68
- Common-Carrier-Provided Facilities 68
- Common-Carrier Switched Telephone Network 68
- Common-Carrier Switched Teletypewriter Exchange (TWX) Networks 68
- Common Controls and Storage (General) 7
- Communication Facilities 68
- Communications Line Addressing 12
- Control Signals 23
- Control-Type Commands 28
- Control Unit Busy 29
- CRC 53
- CSW (Channel Status Word) 11
  
- Data 19
- Data Byte 19
- Data Check (4-Bit), Sense Byte 32, 33, 34
- Data Communication Units 5, 6
- Data Line Set 36
- Data Line Set Expander 36
- Data Service 18
  
- Data Set (Modem) Features 54
- Detailed Description of Operations 11
- Dial 27
- Dial Digits 21
- Disable 28
- DLE 49
  
- EBCDIC--Extended Binary-Coded-Decimal Interchange Code 51
- Effect of Halt I/O Instruction and Zero Byte Count 62
- EIB (Error Index Byte) 16, 50
- Enable 28
- End 18
- End of Address  $\text{\textcircled{D}}$  --EOA 24
- End of Block  $\text{\textcircled{B}}$  --EOB 24
- End of Transmission  $\text{\textcircled{C}}$  --EOT 24
- Ending Status Conditions 29
- ENQ 49
- EOT 50
- EOT, ACK, and NAK 48
- Equipment Check (3-Bit), Sense Byte 31
- ETB and ETX 48, 49
- Exception Commands 28
  
- Feature Limitations per 2703 (Summary) 20
- FIGS (Figures Shift) 43, 44
- Flags, Command 15
  
- General (Both Start/Stop and BSC) Special Features 19
- General Description of BSC Operations 47
- General Description of 2703 Operations 7
  
- Halt I/O 14
- Halt I/O Instruction (Synchronous) 63
- Halt/Stack 18
- High Address Boundary 13
  
- IBM (Intermediate Block Mode) 18
- IBM Line Set 1A 36
- IBM Line Set 1B 36
- IBM Line Set 2 36
- IBM Terminal Control Base 35
- IBM Terminal Control Type I 35
- IBM Terminal Control Type I (Detailed) 39
- IBM Terminal Control Type II 35
- IBM Terminal Control Type II (Detailed) 42
- IBM 2711 Line Adapter Unit 9
- IBM 2712, Typical Configuration 38
- IBM 2712 Remote Multiplexer 9
- Indicators 65
- Inhibit 27
- Initial Status Conditions 29
- Inquiry  $\text{\textcircled{d}}$  --Positive Answer 24
- Internal Organization 8
- Intervention Required (1-Bit), Sense Byte 32, 33, 34
- Introduction to BSC 47
- I/O Character Count 19
- I/O Instructions 14
- I/O Interface Controls 7
- I/O No-Op 28
- ITB 48, 50

Line Base Configurations 37  
 Line Base Features (Summary) 19, 20  
 Line Bases, General 9  
 Line Bases, Start/Stop 36  
 Line Control 23  
 Line-Control Signals 23  
 Line Set Features (Summary) 19, 20  
 Line Sets, General 10  
 Line Sets (per Line Base and per 2703) 38  
 Line Sets, Start/Stop 36  
 Line-Speed Options, Start/Stop 36  
 Lost Data (6-Bit), Sense Byte 31  
 Low Address Boundary 13  
 LRC Check Character 18  
 LTRS (Letters Shift) 43, 44  
  
 Main Control Word 1 (MCW-1) 16  
 Main Control Word 2 (MCW-2) 18  
 Main Data Words 1 and 2 (MDW-1 and MDW-2) 19  
 Maximum Lines Available by Processor Model 13  
 Meter Light 65  
 Meter Switch 65  
 Metering 65  
 Metering with TPS Feature 65, 67  
 Mode 18  
  
 No **N**--Negative Response 24  
  
 Operation with the Multiplexer Channel 14  
 Operator's Control Panel 65, 66  
 Overrun (5-Bit), Sense Byte 31  
  
 Parity 18, 19  
 Partition Switches--CPU 1, CPU 2 65  
 PCI (Program-Controlled Interruption Flag) 15  
 Poll 25  
 Polling and Addressing 41, 42, 43  
 Polling Characters 23  
 Power-On Light and Switch 65  
 Prepare 27  
 Privately Owned Communications Facilities 69  
 Programming Considerations 15  
 PSW (Program Status Word) 11  
 Pwr Off if in Local Switch 65  
  
 Read 27  
 Read and Write Operations in Transparent Mode 59  
 Receive 18  
 Receive Operation (Read Command), Start/Stop 24  
 Receive Operations Using Data-Link Characters 49  
 Receive-Type Commands 27  
 Release 28  
 Reserve 28  
 Restrictions, Channel Attachment 14  
  
 Sadzer, Sadone, Sadtwo, Sadthree 28  
 SBT--Six-Bit Transcode 51  
 Search 28  
 Sense 28  
 Sense Byte 18  
 Sense Byte Conditions 30  
 Sequence 18  
 Shift 18  
 Skip (Skip Flag) 15  
  
 SLI (Suppress Length Indication Flag) 15  
 SOH and STX 48, 49  
 Special Features Summary 19  
 Speed Options (Summary) 20  
 Start I/O 14  
 Start of Address **S**--SOA 24  
 Start/Stop Communications Capabilities 23  
 Start/Stop Special Features 19, 35  
 Station-Selection Feature 54  
 Status Byte 19  
 Status Byte, All Zeros (Normal) 29  
 Status Byte Conditions 28  
 Status Modifier 29  
 Switches 65  
 SYN 48, 49  
 Synchronous Base IA 53  
 Synchronous Base IB 53  
 Synchronous Clock Feature 54  
 Synchronous Line Set 53, 54  
 Synchronous Line-Speed Option 54  
 Synchronous Operations 50  
 Synchronous Terminal Controls (STC) 51  
 Synchronous-Type Communications (Special Features) 20  
 System/360--I/O Operation 11  
  
 Telegraph Line Set 36  
 Telegraph Line Set Expander 36  
 Telegraph Terminal Control Base 35  
 Telegraph Terminal Control Type I (Detailed) 35, 42  
 Telegraph Terminal Control Type II (Detailed) 35, 44  
 Terminal Control Features (Summary) 19, 20  
 Terminal Control Operations 39  
 Terminal Controls, General 9  
 Terminal Controls, Start/Stop 35  
 Terminal-to-Terminal Operation with Search 43  
 Test I/O 15  
 Thermal Light 65  
 Timeout 18  
 Timeout (7-Bit), Sense Byte 32, 33, 34, 35  
 TPS--Automatic Switch to Neutral State 22  
 TPS--Manual Switch to Neutral State 22  
 TPS (Two-Processor Switch) 21  
 Transmission Code Checking 53  
 Transmission Code Transparency 51  
 Transmit and Receive Operations, General 7  
 Transmit Operation (Write Command), Start/Stop 24  
 Transmit Operations Using Data-Link Characters 48  
 Transmit-Type Commands 25  
 Transparent Read Operation 59  
 Transparent Write Operation 59  
 Two-Processor Switch (TPS) Feature 21  
  
 Unit Check 29  
 USASCII--United States of America Standard Code for Information Interchange 51  
  
 VRC/CRC 53  
 VRC/LRC 53  
  
 Western Union Class D (180-Baud) Channels 69  
 Western Union Class E Channels 69  
 Western Union Class F Channels 69  
 Word Parity Indicator 19  
 World Trade Corporation Communication-Interface Facilities 54



Wrap 25  
Write 25

Yes  --Positive Response 24

2703 Common Controls (Detailed) 16  
2712 Attachment Features (Summary) 20  
2712 Model 1 and Model 2 Adapter Features 38  
2741 Break Feature (Detailed) 35

**READER'S COMMENT FORM**

IBM 2703 Transmission Control  
Component Description  
SRL

GA27-2703-1

- Your comments, accompanied by answers to the following questions, help us produce better publications for your use. If your answer to a question is "No" or requires qualification, please explain in the space provided below. Comments and suggestions become the property of IBM.

- |  | Yes                      | No                       |
|--|--------------------------|--------------------------|
| ● Does this publication meet your needs? | <input type="checkbox"/> | <input type="checkbox"/> |
| ● Did you find the material:             |                          |                          |
| Easy to read and understand?             | <input type="checkbox"/> | <input type="checkbox"/> |
| Organized for convenient use?            | <input type="checkbox"/> | <input type="checkbox"/> |
| Complete?                                | <input type="checkbox"/> | <input type="checkbox"/> |
| Well illustrated?                        | <input type="checkbox"/> | <input type="checkbox"/> |
| Written for your technical level?        | <input type="checkbox"/> | <input type="checkbox"/> |

- What is your occupation? \_\_\_\_\_
- How do you use this publication?

As an introduction to the subject?	<input type="checkbox"/>	As an instructor in a class?	<input type="checkbox"/>
For advanced knowledge of the subject?	<input type="checkbox"/>	As a student in a class?	<input type="checkbox"/>
For information about operating procedures?	<input type="checkbox"/>	As a reference manual?	<input type="checkbox"/>

Other \_\_\_\_\_

- Please give specific page and line references with your comments when appropriate. If you wish a reply, be sure to include your name and address.

**COMMENTS:**

- Thank you for your cooperation. No postage necessary if mailed in the U. S. A.

Staple

Fold

Fold

FIRST CLASS  
PERMIT NO. 155  
RALEIGH, N. C.

**BUSINESS REPLY MAIL**  
NO POSTAGE NECESSARY IF MAILED IN THE UNITED STATES

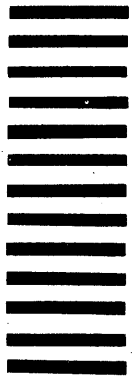

Cut Along Line

POSTAGE WILL BE PAID BY . . .

IBM Corporation  
P. O. Box 12275  
Research Triangle Park  
North Carolina 27709

Attention: Product Publications, Dept. 860

Fold

Fold

**IBM**

International Business Machines Corporation

Field Engineering Division

112 East Post Road, White Plains, N. Y. 10601

**IBM**

**International Business Machines Corporation  
Data Processing Division  
112 East Post Road, White Plains, N.Y. 10601  
[USA Only]**

**IBM World Trade Corporation  
821 United Nations Plaza, New York, New York 10017  
[International]**